



Optec s.c.
ul. Alberta 6E, 16-001 Księżyno k. Białegostoku
tel. (85) 743 74 17, (85) 878 16 10
Fax (85) 734 18 15



Laryngologia

www.medycyna.optec.pl



Laryngologia



Basic Surgical Instruments



Y2001.6 18cm
Needle holder, straight with lock



Needle holder
Y2003.1 14cm Serration
Y2003.2 16cm Serration
Y2003.3 18cm Serration



Y2001
Micro needle holder forceps



Y2006
Scissors for eyes, curved, sharp head



Y2005 10cm
Scissors for eyes, curved, sharp head



Alloy needle holder, Straight, gold-plating
Y2003.6 14cm **Y2003.11** 22cm
Y2003.7 15cm **Y2003.12** 24cm
Y2003.8 16cm **Y2003.13** 26cm
Y2003.9 18cm **Y2003.14** 28cm
Y2003.10 20cm



Scissors, straight, sharp head
Y2007.1 14cm length
Y2007.2 16cm length
Y2007.3 18cm length



Tissue, scissors, straight, blunt head
Y2007.10 20cm length
Y2007.11 19cm length
Y2007.12 17cm length
Y2007.13 14cm length



Y2007.23 14cm
Tissue, scissors, straight, half round



Tissue, scissors, curved, half round
Y2007.28 14cm length
Y2007.30 17cm length



Tissue forceps Ellis head
Y2008.1 width 5mm, length 14cm
Y2008.2 width 5mm, length 16cm
Y2008.3 width 5mm, length 18cm



Hemostatic forceps, straight, full tooth
Y2010.1 12,5cm length
Y2010.2 14cm length
Y2010.3 16cm length
Y2010.4 18cm length
Y2010.5 20cm length
Y2010.6 22cm length



Hemostatic forceps, curved, full tooth
Y2011.1 12,5cm length
Y2011.2 14cm length
Y2011.3 16cm length
Y2011.4 18cm length
Y2011.5 20cm length
Y2011.6 22cm length
Y2011.7 24cm length



Towel forceps, sharp head
Y2013.1 11cm length
Y2013.2 14cm length
Y2013.3 16cm length



Sponge forceps, toothed
Y2016.4 curved, 8 mm, 25cm
Y2016.6 curved, 12 mm, 25cm
Y2016.2 straight, 12 mm, 25cm

Optec s.c.

ul. Alberta 6E, 16-001 Księżyno k. Białegostoku
tel. 85 743 74 17, 85 878 16 10 wew. 102
e-mail: medycyna@optec.pl





Laryngologia

Basic Surgical Instruments



Y2020.1 125mm Tweezers, Straight
Y2020.5 125mm Tweezers, Straight with hook



Y3001.1 3 12,5cm Handle



Y2020.8 125mm Tissue tweezer, straight



Y3001.4 4 13,5cm Handle (with L blade)



Tissue tweezer
Y2020.9 1x2 125mm straight, 1x2 tooth,S
Y2020.10 1x2 125mm straight, 1x2 tooth,L



Handle
Y3001.7 7 12,5cm
Y3001.8 7 16,5cm



Tweezers
C2049 160mm
C2049.1 200mm
C2049.2 160mm head with hook
C2049.3 195mm head with hook
C2049.4 180mm head with hook
C2049.6 180mm



Tuning forks
C2036.1 128
C2036.2 256



Tweezers
C2050 110mm
C2050.1 110mm head with hook
C2050.2 160mm head with hook



Tuning forks
C2036.3 512 **C2036.5** 1024
C2036.4 2048 **C2036.6** 4096



C2100 Fascia presser



C1001.1 Ear speculum $\varnothing 3, \varnothing 4, \varnothing 5$
 3pcs/set



Fascia forceps
C2100.1 (L)
C2100.2 (M)
C2100.3 (S)



C1001.2 Ear speculum $\varnothing 3, \varnothing 4, \varnothing 5$
 3pcs/set





Laryngologia



WZ-2 Shaver system with pump

B3102.2
Foot pedal programmable

B3101.2
Control unit with pump

B3201.2
Otology handpiece motor without brush

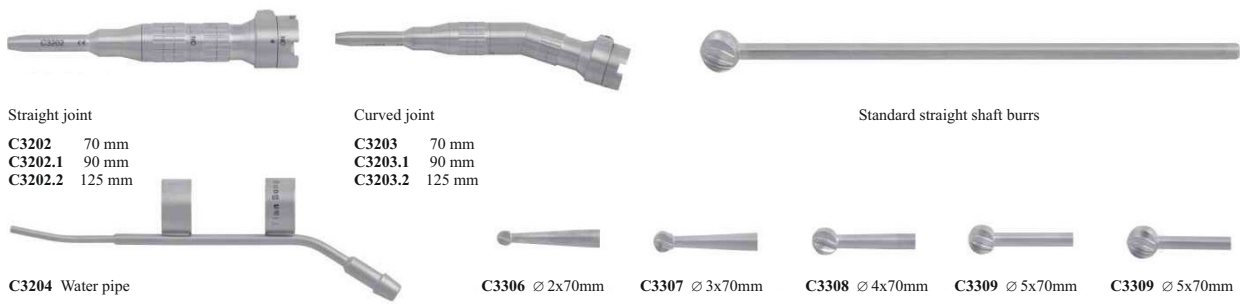

Straight joint

- C3202 70 mm
- C3202.1 90 mm
- C3202.2 125 mm

Curved joint

- C3203 70 mm
- C3203.1 90 mm
- C3203.2 125 mm

Standard straight shaft burrs

C3204 Water pipe

C3306 \varnothing 2x70mm

C3307 \varnothing 3x70mm

C3308 \varnothing 4x70mm

C3309 \varnothing 5x70mm

C3309 \varnothing 5x70mm

WZ-4 Shaver system

C3404 Control unit

C3405 Foot pedal

B3401
Otology handpiece motor without brush

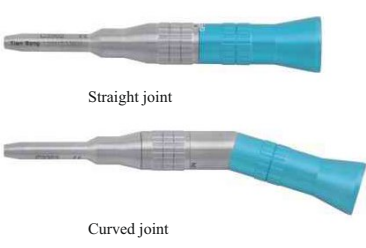

Straight joint

Curved joint

- C3302 70mm
- C3302.1 90mm
- C3302.2 125mm

- C3303 70mm
- C3303.1 90mm
- C3303.2 125mm

Standard straight shaft burrs

- C3306 \varnothing 2x70mm
- C3307 \varnothing 3x70mm
- C3308 \varnothing 4x70mm
- C3309 \varnothing 5x70mm
- C3310 \varnothing 6x70mm

Optec s.c.

ul. Alberta 6E, 16-001 Księżyno k. Białegostoku
tel. 85 743 74 17, 85 878 16 10 wew. 102
e-mail: medycyna@optec.pl





Laryngologia

Otoscope

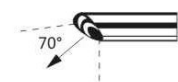
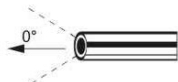

C 0010	0°	∅ 2,7 x 107mm
C 0010A	0°	∅ 3 x 107mm
C 0010.1	0°	∅ 2,7 x 107mm, 134°C 2bar
C 0010.1A	0°	∅ 3 x 107mm, 134°C 2bar
C 0010.1B	0°	∅ 3 x 90mm
C 0010.1C	0°	∅ 3,3 x 90mm
C 0010.2	0°	∅ 2,7 x 107mm
C 0020	0°	∅ 2,7 x 55mm
C 0020A	0°	∅ 3 x 55mm
C 0020.1	0°	∅ 2,7 x 55mm, 134°C 2bar
C 0020.1A	0°	∅ 3 x 55mm, 134°C 2bar
C 0030	0°	∅ 4 x 55mm
C 0030.1	0°	∅ 4 x 55mm, 134°C 2bar

C 0012	30°	∅ 2,7 x 107mm
C 0012A	30°	∅ 3 x 107mm
C 0012.1	30°	∅ 2,7 x 107mm, 134°C 2bar
C 0012.1A	30°	∅ 3 x 107mm, 134°C 2bar
C 0012.2	30°	∅ 2,7 x 55mm
C 0022	30°	∅ 2,7 x 107mm
C 0022A	30°	∅ 3 x 55mm
C 0022.1	30°	∅ 2,7 x 55mm, 134°C 2bar
C 0022.1A	30°	∅ 3 x 55mm, 134°C 2bar
C 0032	30°	∅ 4 x 55mm
C 0032.1	30°	∅ 4 x 55mm, 134°C 2bar

C 0013	70°	∅ 2,7 x 107mm
C 0013A	70°	∅ 3 x 107mm
C 0013.1	70°	∅ 2,7 x 107mm, 134°C 2bar
C 0013.1A	70°	∅ 3 x 107mm, 134°C 2bar
C 0013.2	70°	∅ 2,7 x 55mm
C 0023	70°	∅ 2,7 x 107mm
C 0023A	70°	∅ 3 x 55mm
C 0023.1	70°	∅ 2,7 x 55mm, 134°C 2bar
C 0023.1A	70°	∅ 3 x 55mm, 134°C 2bar
C 0033	70°	∅ 4 x 55mm
C 0033.1	70°	∅ 4 x 55mm, 134°C 2bar

1. Connecting to TIANSONG light guide cable
Connecting to OLYMPUS light guide cable
2. Connecting to STORZ light guide cable
3. Connecting to WOLF light guide cable



Middle ear forceps 70mm



C2001 Punch head
(Head length 5mm)



C2002 Right head
(Head length 5mm)



Triticeous head
C2003.1 Large (Head length 5mm)
C2003.2 Small (Head length 3,5mm)
C2003.3 Upward 30°
C2003.4 (Head length 11mm)



C2004 Cup head 45°
(Head length 5mm)



C2004.2 Cup head, right-curved 45°



Cup head
C2005.1 Large (Head length 5mm)
C2002.2 Small (Head length 4mm)



C2006 Polyp scissor, straight
(Head length 4mm)



Polyp scissor
C2006.1 Left curved (Head length 4mm)
C2006.2 Right curved (Head length 4mm)



C2013 Stapes install forceps
(Head length 5mm)



Malleus arch scissors
C2014 Left upward
C2015 Right upward



C2060 Malleus rongeur scissors
(80mm)



C2061 Malleus rongeur scissors
(110mm)



C2066 Olive head
(Head length 5mm)



C2067 Straight bowl
(Head length 3,5mm)



C2068 Triticeous head
(Head length 3,5mm)



C2069 Straight scissors
(Head length 3,5mm)

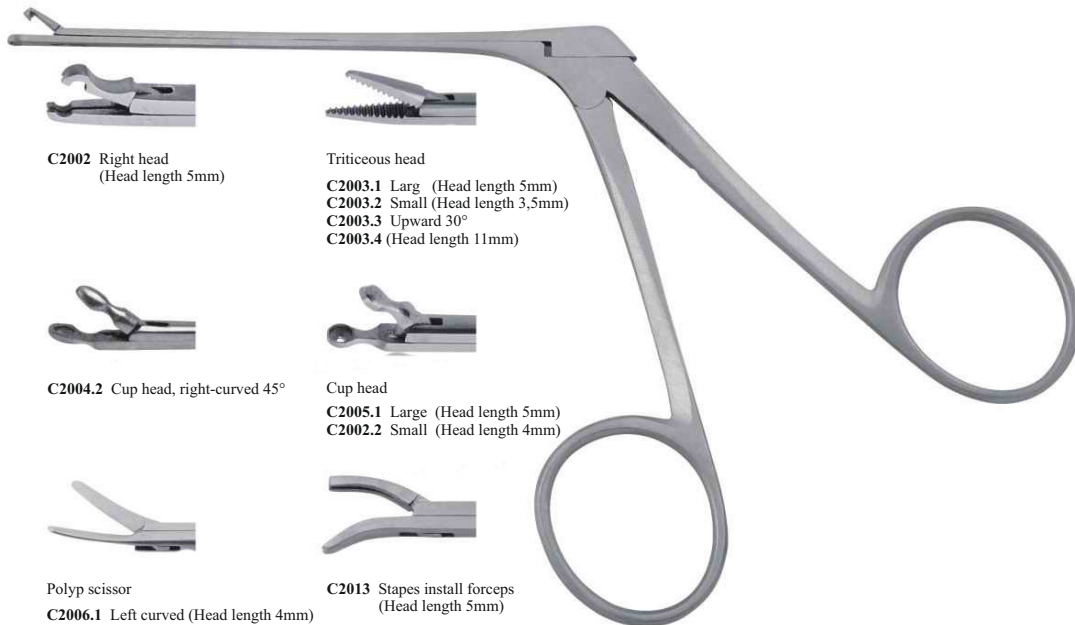



Laryngologia



Otoscopy instruments



Curette, straight and blunt mouth
C2016.1 ∅ 4cm
C2016.2 ∅ 3cm
C2016.3 ∅ 2cm



Curette, curved and blunt mouth
C2017.1 ∅ 4cm
C2017.2 ∅ 3cm
C2017.3 ∅ 2cm



Curette, straight and sharp mouth
C2018.1 ∅ 4cm
C2018.2 ∅ 3cm
C2018.3 ∅ 2cm



Curette, curved and sharp mouth
C2019.1 ∅ 4cm
C2019.2 ∅ 3cm
C2019.3 ∅ 2cm



C2058 Auditory lamellette knife straight 160mm (Head width 2,5mm)



C2059.1 45° Auditory lamellette knife angled 2,5mm, 160mm



C2059.2 45° Auditory lamellette knife angled 2mm, 160mm



Micro ear hook (160mm)
C2062.1 0,3mm
C2062.2 0,6mm
C2062.3 1 mm



C2064 (160mm) Micro ear needle, straight
C2052 Cerumen hook, curved



C2065 45° Micro ear needle, curved
C2079 45° Cerumen hook, head curved



Periosteotome, half-moon blade
C2040 Bayonet shaped
C2042 Angle shaped



Periosteotome, triangular blade
C2041 Bayonet shaped
C2043 Angle shaped



C2053 Cerumen hook, curved



Cerumen hook, bayonet shaped
C2051.1 2mm blade width 2mm
C2051.2 4mm blade width 4mm



C2080 Micro cerumen hook, 9 pcs



C2074 Micro cerumen hook, 21 pcs

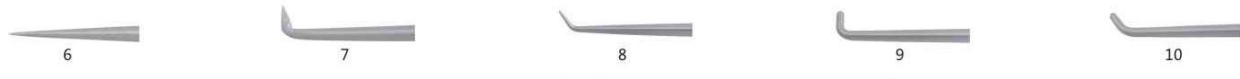



Laryngologia

Otoscopy instruments

C6 Hyperfine otology instruments

1. Customized special stainless steel: high strength , good corrosion resistant.
2. Vacuum head treatment technology: vacuum oil quenching and Vacuum tempering. The parts are non oxidation, no decarburization, good surface quality, microstructure uniformity, and high comprehensive mechanical properties.
3. Use the Swiss leading CNC machine and technology which has high precision.
4. Use the leading surface treatment technology. Effectively remove the injurants to the human body, improve the corrosion.

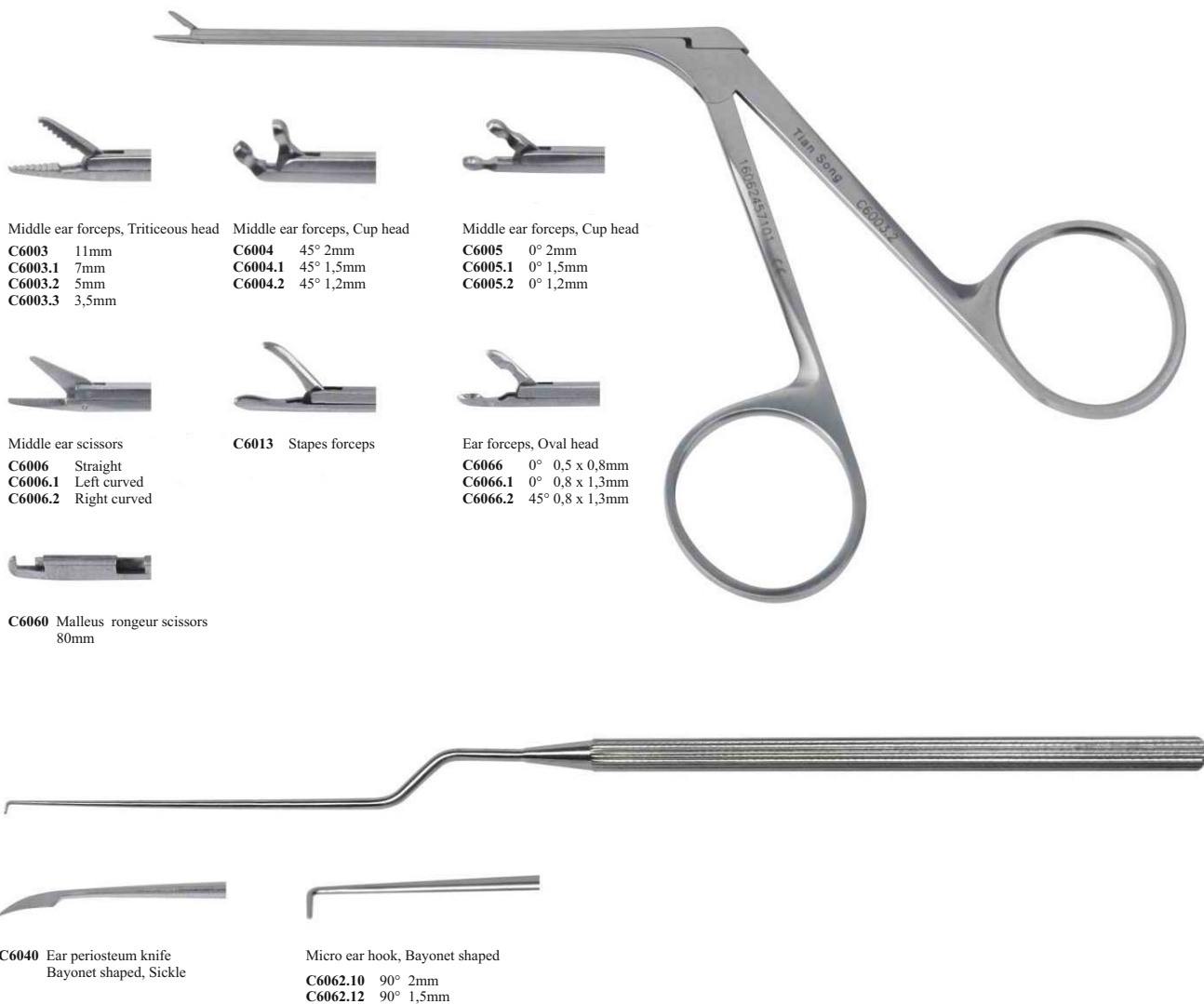



Laryngologia



Otoscopy instruments



C6042.1 Micro ear knife, Sickel



C6043 Micro ear knife, Triangle



C6048.1 Ear probe Head 0,5mm
For the cochlea electrode fascia filling



C6048.2 Ear probe 25°



C6048.3 Ear probe 45°



Micro ear knife, straight cut
C6058.1 0° 2cm
C6058.2 0° 2,5cm



Micro ear knife, straight cut
C6059.1 45° 1cm
C6059.2 45° 1,2cm
C6059.3 45° 1,5cm
C6059.4 45° 1,8cm
C6059.5 45° 2cm
C6059.6 45° 2,5cm



Micro ear knife, straight cut
C6059.8 90° 1cm
C6059.9 90° 1,2cm
C6059.10 90° 1,5cm
C6059.11 90° 1,8cm
C6059.12 90° 2cm



Micro ear hook
C6062.2 90° 0,6cm
C6062.3 90° 1cm
C6062.4 90° 1,2cm
C6062.5 90° 1,5cm
C6062.6 90° 1,8cm
C6062.7 90° 2cm



Ear probe
C6064.1 Slightly curved, sharp head
C6064.2 Straight, sharp head



Micro ear hook
C6065 45° 0,8cm
C6065.2 45° 1,2cm
C6065.3 45° 1,5cm
C6065.4 45° 1,8cm
C6065.5 45° 2cm



Micro ear hook
C6065.6 25° Short
C6065.7 25° Long



Micro ear curet, Oval head slightly curved
C6071.1 1,5 x 1,2cm
C6071.2 1,8 x 1,5cm
C6071.3 2,2 x 1,8cm



Micro ear elevator, Oval Slightly curved
C6073.1 1,5cm
C6073.2 2cm
C6073.3 3cm



C6073.4 Micro ear elevator, Curved 1,8mm



Micro ear elevator
C6073.5 Left curved
C6073.6 Right curved



ENT suction tube, Straight, with handle
C6046.11 ∅ 3 x 85mm
C6046.12 ∅ 3,5 x 85mm
C6046.13 ∅ 4 x 85mm
C6046.14 ∅ 4,5 x 85mm
C6046.15 ∅ 5 x 85mm



ENT suction tube, Straight, with reducing valve
C6046.21 ∅ 3 x 85mm
C6046.22 ∅ 2,5 x 85mm
C6046.23 ∅ 2 x 85mm
C6046.24 ∅ 1,8 x 85mm
C6046.25 ∅ 1,5 x 85mm
C6046.26 ∅ 1,2 x 85mm
C6046.27 ∅ 1 x 85mm



C6075 ENT suction tube, Slightly curved ∅ 2 mm





Laryngologia

Otoscopy instruments

C5 Black gold hyperfine otology instruments

Based on the C6 products, using PVD black gold coating.

1. To avoid reflections in the operation, reduce the fatigue of doctor's eye.
2. Improve corrosion resistance and abrasion resistance, extend the life of the product.
3. After processing, the product surface is smooth, no easy to rust, stain is not easy to bonding, make cleaning and sterilization more thoroughly, more secure.
4. Good biological compatibility, make the product in such aspects as hemolysis and sensitive with better performance.

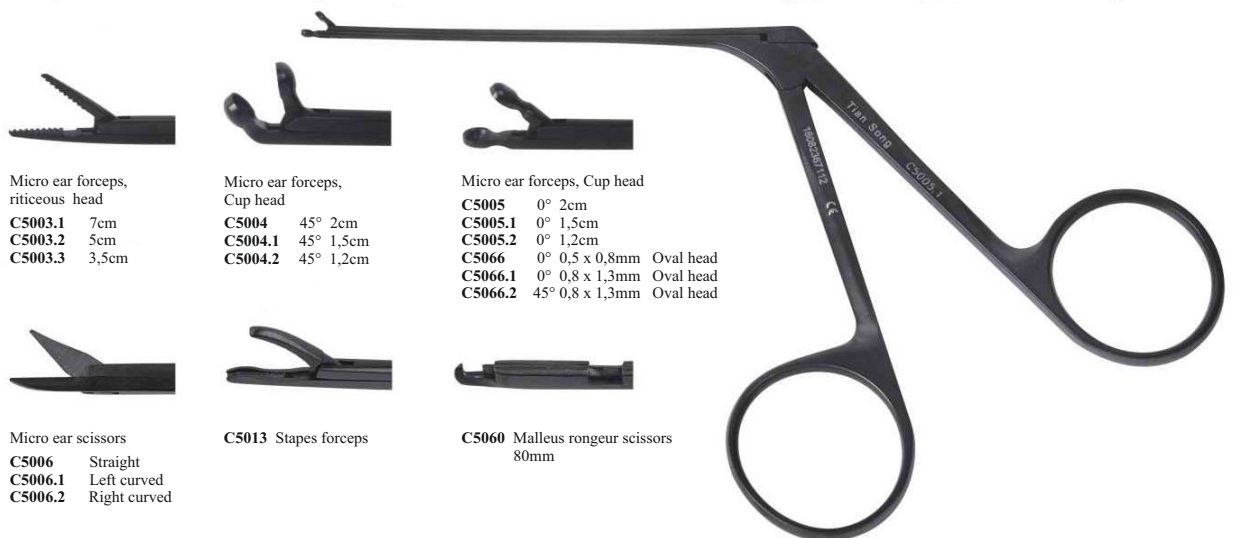

Micro ear forceps, riticeous head

C5003.1 7cm
C5003.2 5cm
C5003.3 3,5cm

Micro ear forceps, Cup head

C5004 45° 2cm
C5004.1 45° 1,5cm
C5004.2 45° 1,2cm

Micro ear forceps, Cup head

C5005 0° 2cm
C5005.1 0° 1,5cm
C5005.2 0° 1,2cm
C5066 0° 0,5 x 0,8mm Oval head
C5066.1 0° 0,8 x 1,3mm Oval head
C5066.2 45° 0,8 x 1,3mm Oval head

Micro ear scissors

C5006 Straight
C5006.1 Left curved
C5006.2 Right curved

C5013 Stapes forceps

C5060 Malleus rongeur scissors 80mm



C5042.1 Micro ear knife, Sickle
C5040 Ear periosteum knife, Bayonet shaped



C5048.1 Ear probe
For the cochlea electrode fascia filling
Head 0,5mm



C5048.2 25° Ear probe



C5048.2 45° Ear probe



Micro ear knife
C5058.1 Straight cut 0° 2mm
C5058.2 Straight cut 0° 2,5mm



Micro ear knife
C5059.1 45° 1mm
C5059.2 45° 1,2mm
C5059.3 45° 1,5mm
C5059.4 45° 1,8mm
C5059.5 45° 2mm
C5059.6 45° 2,5mm



Micro ear knife
C5059.8 90° 1mm
C5059.9 90° 1,2mm
C5059.10 90° 1,5mm
C5059.11 90° 1,8mm
C5059.12 90° 2mm
C5059.13 90° 2,5mm



Micro ear knife
C5062.2 90° 0,6mm
C5062.3 90° 1mm
C5062.4 90° 1,2mm
C5062.5 90° 1,5mm
C5062.6 90° 1,8mm
C5062.7 90° 2mm
C5062.10 Bayonet shaped 90° 2mm
C5062.12 Bayonet shaped 90° 1,5mm



Ear probe
C5064.1 Slightly curved, sharp head
C5064.2 Straight, sharp head



Micro ear hook
C5065 0,8mm
C5065.1 45° 1mm
C5065.2 45° 1,2mm
C5065.3 45° 1,5mm
C5065.4 45° 1,8mm
C5065.5 45° 2mm
C5065.6 25° Short
C5065.7 25° Long



Micro ear curet
Oval head, Slightly curved
C5071.1 1,5 x 1,2mm
C5071.2 1,8 x 1,5mm
C5071.3 2,2 x 1,8mm

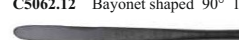

Micro ear elevator
C5073.1 Slightly curved 1,5mm
C5073.2 Slightly curved 2mm
C5073.3 Slightly curved 3mm
C5073.4 Curved 1,8mm
C5073.5 Left curved
C5073.6 Right curved



Optec s.c.

ul. Alberta 6E, 16-001 Ksieżyno k. Białegostoku
tel. 85 743 74 17, 85 878 16 10 wew. 102

e-mail: medycyna@optec.pl



Laryngologia



Otoscopy instruments



C2056 Headlight



C2056.3 Headlight LED high brightness, witch charger



C2056.2 Light guide cable for headlight
∅ 3 x 2500mm



Charger



Standard straight sharp burrs

C3306.1	∅ 2 x 90mm	C3306.2	∅ 2 x 125mm	C3320	∅ 1,5 x 70mm
C3307.1	∅ 3 x 90mm	C3307.2	∅ 3 x 125mm	C3321	∅ 2,5 x 70mm
C3308.1	∅ 4 x 90mm	C3308.2	∅ 4 x 125mm	C3322	∅ 3,5 x 70mm
C3309.1	∅ 5 x 90mm	C3309.2	∅ 5 x 125mm	C3323	∅ 4,5 x 70mm
C3310.1	∅ 6 x 90mm	C3310.2	∅ 6 x 125mm		



Diamond straight sharp burrs

C3311	∅ 2 x 70mm	C3311.1	∅ 2 x 90mm	C3329	∅ 1,4 x 70mm
C3312	∅ 3 x 70mm	C3312.1	∅ 3 x 90mm	C3330	∅ 2,7 x 70mm
C3313	∅ 4 x 70mm	C3313.1	∅ 4 x 90mm	C3331	∅ 3,5 x 70mm
C3314	∅ 5 x 70mm	C3314.1	∅ 5 x 90mm	C3332	∅ 4,5 x 70mm
C3315	∅ 6 x 70mm	C3315.1	∅ 6 x 90mm		



C1001 Otoscopy sheath

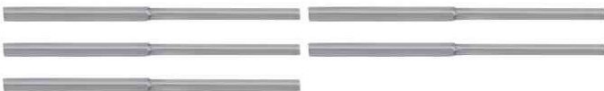

C2077 Suction head
∅ 1,5 x 30mm



C2055 Cotton applicator



C2055.1 Cotton applicator, spring handle



Spiral head



Triangular head



Spiral head



Triangular head



Suction tube, upward

C2081	∅ 2 x 110mm
C2082	∅ 1,5 x 110mm
C2083	∅ 1 x 110mm

Suction tube, downward

C2081.1	∅ 2 x 110mm
C2082.1	∅ 1,5 x 110mm
C2083.1	∅ 1 x 110mm

Suction tube, curved

C2078.1	∅ 4 x 80mm
C2078.2	∅ 3 x 80mm
C2078.3	∅ 2,5 x 80mm
C2078.4	∅ 2 x 80mm



C2047 Probe, Bayonet shaped ∅ 2,5mm

C2048 Probe, knee shaped ∅ 2mm

Optec s.c.

ul. Alberta 6E, 16-001 Księżyno k. Białegostoku
tel. 85 743 74 17, 85 878 16 10 wew. 102
e-mail: medycyna@optec.pl





Laryngologia

Oświetlacze czołowe



KS-W 04 (5W) Headlight LED high brightness,
with charger, distance of working shafts 200-400mm,
magnification 2.5x-3.5x



KD-202 A2 (3W) Headlight LED high brightness,
with charger



KD-202 A-6 (5W) Headlight LED high brightness,
with charger



JD 2000 (5W) Headlight LED high brightness,
with charger





Laryngologia



Oświetlacze czołowe



KD-202 A-7 (3W) Headlight LED high brightness,
with charger



KD-202 A-7 (5W) Headlight LED high brightness,
with charger



KD-203 A Fiber optic Headpiece with Diaphragm





Laryngologia

Otoscopy instruments



Pleaster self retaining retractors
C2038 130cm
C2038.1 Single tooth



Pleaster self retaining retractors
C2038.2 2 x 2 sharp head, curved
C2038.3 2 x 2 blunt head, curved



Mastoid retractors
C2038.4 130cm, 3 x 4 tooth, blunt



Mastoid retractors
C2038.7 130mm, 3 teeth, left, sharp, curved



Mastoid retractors
C2038.8 130cm, 3 teeth, right, sharp, curved



C2039 Backman laminectomy retractors 160mm



C2039.1 Backman laminectomy retractors 160mm



C2044 Polyp scissors 140mm



C2045 Polyp snare





Laryngologia



Otoscopy instruments



C6026.1 ∅ 3mm, ∅ 4mm
Mastoid curette, round bowl, double heads



Micro ear curette
C2070.1 ∅ 2mm, double heads, large
C2070.2 ∅ 1,5mm, double heads, small



C2071 ∅ 2mm Micro ear curette, Only head



C2075 ∅ 2 x 90mm Suction tube, micro curved



C2076 ∅ 2 x 90mm Suction tube, straight



Mastoid curette, 160mm
C2022 ∅ 1,5mm **C2027** ∅ 4mm
C2023 ∅ 2mm **C2028** ∅ 4,5mm
C2024 ∅ 2,5mm **C2029** ∅ 5mm
C2025 ∅ 3mm **C2030** ∅ 5,5mm
C2026 ∅ 3,5mm **C2031** ∅ 6mm



Mastoid suction tube 105mm
C2035.1 ∅ 3mm **C2035.4** ∅ 1,5mm
C2035.2 ∅ 4mm **C2035.5** ∅ 2mm
C2035.3 ∅ 5mm **C2035.6** ∅ 2,5mm



Suction tube 125mm straight
C2046.1 ∅ 4mm
C2046.2 ∅ 3mm
C2046.3 ∅ 2,5mm
C2046.9 ∅ 3,5mm
C2046.10 ∅ 2 x 125mm



Suction tube 85mm
C2046.4 ∅ 1mm
C2046.5 ∅ 1,5mm
C2046.6 ∅ 2mm
C2046.7 ∅ 2,5mm
C2046.8 ∅ 3mm

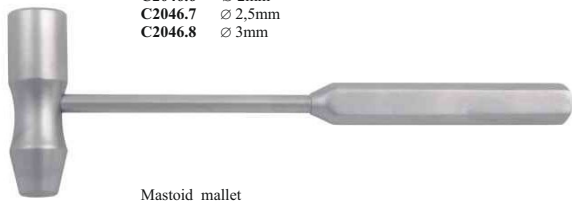

Mastoid mallet
C2034.1 ∅ 19 x 60mm
C2034.2 ∅ 17 x 55mm
C2034.3 ∅ 15 x 50mm



C2034.4 Mastoid mallet, rubber



C2034.7 Mastoid mallet, rubber with needle



Foreign body forceps

C2007.1 Small triticeous head (head width 2mm)
C2007.2 Large triticeous head (head width 3mm)



Mastoid rongeur forceps, bayonet shaped (90mm)
C2008.1 Head width 6mm
C2008.2 Head width 5mm
C2008.3 Head width 4mm

Mastoid hemostatic forceps, bayonet shaped (90mm)
C2008.5 Head width 5mm
C2008.6 Head width 4mm





Laryngologia

Otoscopy instruments



C2010 Beyer bone rongeur



Mastoid rongeur forceps, single joint
C2011 Sharp head
C2011.1 Sharp head, curved 140mm
C2012 Round head



Ear bone chisel, round blade 125mm

- | | |
|---------------------------------|---------------------------------|
| C2020.1 Head width 2,6mm | C2020.5 Head width 3,4mm |
| C2020.2 Head width 2,8mm | C2020.6 Head width 3,6mm |
| C2020.3 Head width 3mm | C2020.7 Head width 3,8mm |
| C2020.4 Head width 3,2mm | |



Ear bone chisel, flar blade 125mm

- | |
|---------------------------------|
| C2021.1 Head width 4mm |
| C2021.2 Head width 4,4mm |
| C2021.3 Head width 4,8mm |



Mastoid chisel 145mm

- | |
|-------------------------------|
| C2032.1 Head width 5mm |
| C2032.2 Head width 4mm |
| C2032.3 Head width 3mm |



Mastoid gouge 145mm

- | |
|---------------------------------|
| C2033.1 Head width 4,5mm |
| C2033.2 Head width 4mm |
| C2033.3 Head width 3,5mm |



C2047.1 Probe, double ball heads

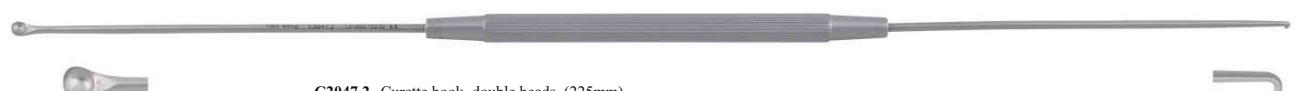

C2047.2 Curette hook, double heads (225mm)



C2084 Micro hook, double heads



C2054 Cerumen hook, 7 pcs





Laryngologia



Sinuscope

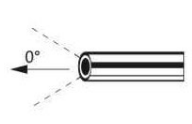

- B 0110 0° Ø 4 x 175mm
- B 0210 0° Ø 2,7 x 175mm
- B 0210A 0° Ø 3 x 175mm
- B 0120 0° Ø 4 x 175mm, 134°C 2bar
- B 0310 0° Ø 2,7 x 175mm, 134°C 2bar
- B 0310A 0° Ø 3 x 175mm, 134°C 2bar



- B 0112 30° Ø 4 x 175mm
- B 0212 30° Ø 2,7 x 175mm
- B 0212A 30° Ø 3 x 175mm
- B 0122 30° Ø 4 x 175mm, 134°C 2bar
- B 0312 30° Ø 2,7 x 175mm, 134°C 2bar
- B 0312A 30° Ø 3 x 175mm, 134°C 2bar



- B 0116 45° Ø 4 x 175mm
- B 0116.1 45° Ø 4 x 175mm, 134°C 2bar

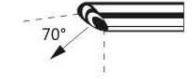

- B 0113 70° Ø 4 x 175mm
- B 0213 70° Ø 2,7 x 175mm
- B 0213A 70° Ø 3 x 175mm
- B 0123 70° Ø 4 x 175mm, 134°C 2bar



Sinuscope



Sinuscope

- B 0040 0° Ø 4 x 175mm
- B 0042 30° Ø 4 x 175mm
- B 0043 70° Ø 4 x 175mm
- B 0044 45° Ø 4 x 175mm

Nasal operating forceps



- Nasal tissue forceps
- B 2007.1 Left curved (Large)
 - B 2007.2 Left curved (Small)
 - B 2008.1 Right curved (Large)
 - B 2008.2 Right curved (Small)



B 2019 Nasal biopsy forceps, straight
Ø 3,5 x 110mm



Nasal biopsy forceps, 0° 145mm
B 2109 Open to left
B 2110 Open to right



B 2028 (110mm)
Nasal forgein body forceps,
without hook



B 2029 (110mm)
Nasal forgein body forceps,
with hook



B 2020 Nasal biopsy forceps
Ø 3,5 x 110mm



B 2021 Nasal biopsy forceps, curved
Ø 3,5 x 110mm



Nasal grasping forceps 105mm
B 2043 90°/120° Downward 90°, open to back 120°
B 2043.2 90°/120° Upward 90°, open to back 120°



Nasal grasping forceps 105mm
B 2043.1 Long curved, downward 115°
B 2043.3 Long curved, upward 115°



Nasal grasping forceps
B 2043.4 Curved, downward 80°
B 2043.5 Long curved, downward 80°
B 2043.6 Downward 90°, back open 120°

Optec s.c.

ul. Alberta 6E, 16-001 Ksiezyno k. Bialogostoku
tel. 85 743 74 17, 85 878 16 10 wew. 102
e-mail: medycyna@optec.pl





Laryngologia

Nasal operating forceps

B 2010.1 0° Sharp head (L) B 2010.2 0° Sharp head (S)	B 2011.1 30° Sharp head (L) B 2011.2 30° Sharp head (S)	B 2012.1 45° Sharp head (L) B 2012.2 45° Sharp head (S)	
B 2013.1 0° Round head (L) B 2013.2 0° Round head (S)	B 2014.1 30° Round head (L) B 2014.2 30° Round head (S)	B 2015.1 45° Round head (L) B 2015.2 45° Round head (S)	
B 2514 Nasal tissue forceps, front biting 0°/105mm	B 2515 Nasal tissue forceps, front biting, sharp small 0°/105mm	B 2016 Front biting sharp (small) 30°/105mm B 2016.1 Front biting sharp (small) 45°/105mm	
B 2094.1 0° B 2094.5 Left biting B 2094.6 Right biting	B 2094.2 30° B 2094.7 Left biting B 2094.8 Right biting B 2094.9 45°	B 9094.1 (0°/105mm) Rongeur of nasal ethmoid	B 9094.2 (30°/105mm) Rongeur of nasal ethmoid
B 2099.1 (110°/105mm) Open to left and right	B 2105 (100°/105mm) Open to left and right B 2106 (70°/105mm) Open to left and right B 2107 (70°/105mm) Open to front and back	B 2108 (0°/145mm) Open to up and down	
B 2095 Blade with tooth, straight	B 2096 Blade with tooth, left curved	B 2097 Blade with tooth, right curved	B 2111 90° 140mm Nasal tissue forceps, with suction tube





Laryngologia



Nasal operating forceps



Nasal tissue forceps, without fixed pin (0°/105mm)
B 2517.1 Large
B 2517.2 Middle
B 2517.3 Small
B 2517.4



Nasal tissue forceps, without fixed pin (45°/105mm)
B 2519.1 Large
B 2519.2 Small



B 9100 Tissue forceps, of nasal cavity sharp head, without fixed pin (0°/105mm)



B 9101 Tissue forceps of nasal cavity sharp head, without fixed pin (30°/105mm)



B 9102 Tissue forceps of nasal cavity sharp head, without fixed pin (45°/105mm)



B 9103 Tissue forceps of nasal cavity sharp head, without fixed pin (90°/105mm)



B 9104 Tissue forceps of nasal cavity sharp head, without fixed pin (0°/105mm)



B 2022 Tissue polyp ethmoid forceps Round head (130mm)



B 2023 Nasal polyp ethmoid forceps sharp head (130mm)



Tissue forceps of nasal cavity with suction tube (0°/105m)
B 2039 (L)
B 2039.1 (M)



Tissue forceps of nasal cavity with suction tube (30°/105m)
B 2040 (L)
B 2040.1 (M)



Tissue forceps of nasal cavity with suction tube (105mm) 45°
B 2041 (L)
B 2041.1 (M)



Tissue forceps of nasal cavity with suction tube (105mm) 90°
B 2042 (L)
B 2042.1 (M)



Nasal tissue forceps (0°/105mm)
B 2100 (L) Sharp shead
B 2100.1 (M)
B 2100.2 (S)
B 2100M Sharp shead 130mm



Nasal tissue forceps (30°/105mm)
B 2101 Sharp shead
B 2101.1 (L)
B 2101.2 (S)



Nasal tissue forceps 105mm (Sharp shead)
B 2102 45°
B 2103 90°



B 2080 (105mm) Open forceps of nasal ethmoid Flat head



B 2081 (105mm) Open forceps of nasal ethmoid Up head



Open forceps of nasal ethmoid sharp head (105mm)
B 2082 (L)
B 2082.1 (S)



B 2085 (150mm) Nasal-pharyngeal biopsy forceps straight



B 2086 (150mm) Nasal-pharyngeal biopsy forceps



B 2086.1 (150mm) 70° Nasal-pharyngeal biopsy forceps Upward



B 2087 (180mm) Nasal-pharyngeal biopsy forceps Curved



B 2095.1 (105mm) Nasal tissue scissors Straight



Nasal tissue scissors (105mm)
B 2096.1 Left curved
B 2097.1 Right curved



B 2098 (105mm) Nasal rongeur front biting



B 2099 Back biting rongeur 130mm
B 2099M 130mm
B 2099.1 Left opening
B 2099.2 Right opening
B 2099.1M 130mm left open
B 2099.2M 130mm right open



B 2099.3 (105mm) Back biting rongeur Down curved



B 2099.9 Suture removing forceps



B 2099.10 Foreign body forceps



Polyp forceps of nasal cavity (0°/105mm)
B 2104 Round head

Optec s.c.

ul. Alberta 6E, 16-001 Ksieżyno k. Białegostoku
 tel. 85 743 74 17, 85 878 16 10 wew. 102

e-mail: medycyna@optec.pl





Laryngologia

Nasal instruments



B 2099.8 Grasping forceps, three teeth

B 2018.1 (200mm) Nasal mucosa forceps, type 1
B 2018.2 (200mm) Nasal mucosa forceps, type 2
 Nasal mucosa forceps, new type
B 2018.3 (L)

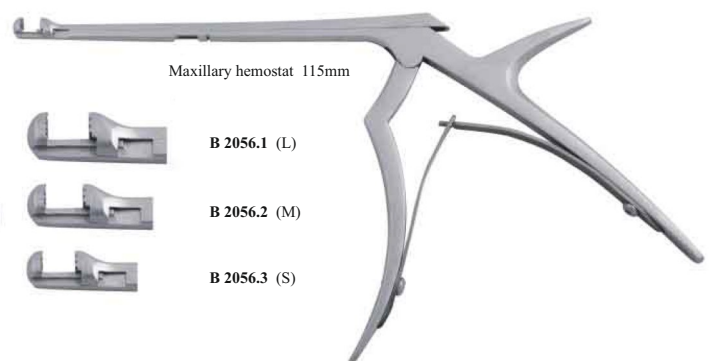

Maxillary hemostat 115mm

B 2056.1 (L)
B 2056.2 (M)
B 2056.3 (S)



Nasal polyp forceps, triticeus head
B 2025.1 2 x 6 x 180mm
B 2025.2 2,5 x 6 x 180mm
B 2025.3 3 x 6 x 180mm



Nasal polyp forceps, new type
B 2026.1 2 x 6mm
B 2026.2 2,5 x 6mm
B 2026.3 3 x 6mm



Nasal polyp forceps
B 2027.1 2 x 6
B 2027.2 2,5 x 6
B 2027.3 3 x 6



B 2001 0°/150mm
 Optical forceps

B 2002 30°/120mm
 Optical forceps, flexible

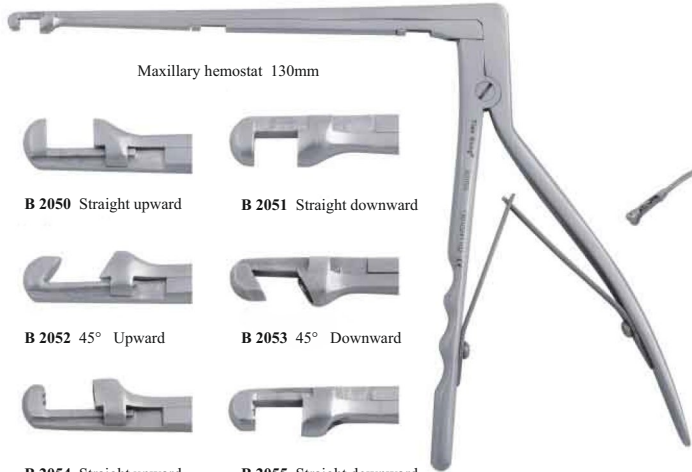

Maxillary hemostat 130mm

B 2050 Straight upward **B 2051** Straight downward
B 2052 45° Upward **B 2053** 45° Downward
B 2054 Straight upward, mouth with tooth **B 2055** Straight downward, mouth with tooth





Laryngologia



Nasal operating forceps



B 2003 70°/120mm
Optical forceps



B 2302 70°, 3x130mm
Side cutting forceps

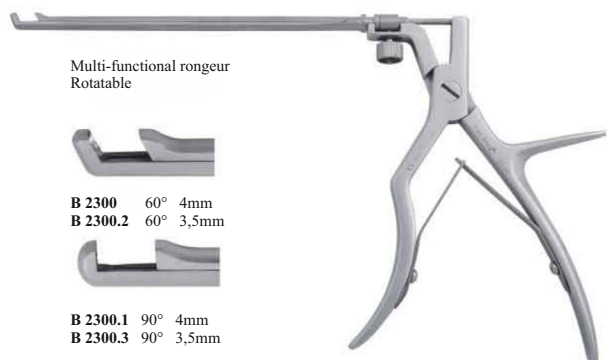

Multi-functional rongeur
Rotatable

B 2300 60° 4mm
B 2300.2 60° 3,5mm

B 2300.1 90° 4mm
B 2300.3 90° 3,5mm



Nasal bipolar forceps
Use with M1020 high frequency cord

B 2125 0°
B 2125.1 20° Upward 20°

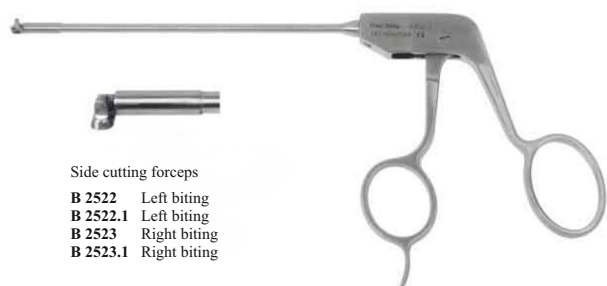

Side cutting forceps

B 2522 Left biting
B 2522.1 Left biting
B 2523 Right biting
B 2523.1 Right biting

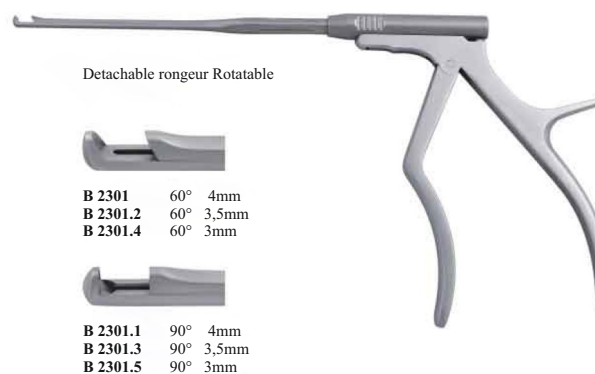

Detachable rongeur Rotatable

B 2301 60° 4mm
B 2301.2 60° 3,5mm
B 2301.4 60° 3mm

B 2301.1 90° 4mm
B 2301.3 90° 3,5mm
B 2301.5 90° 3mm



Back biting rongeur, Rotatable (360°)

B 2513
B 2513.1
B 2513.2



Nasal rongeur, sharp head (100mm)

B 2530 0° **B 2532** 45°
B 2531 30° **B 2533** 90°

B 2529 0° Nasal rongeur,
4x3x135mm, 30°

Nasal tissue cutting forceps (2mm)
B 2534 0°
B 2535 30°
B 2536 45°

B 2537 0° Nasal rongeur,
Left - curved

Optec s.c.

ul. Alberta 6E, 16-001 Ksieżyno k. Białegostoku
tel. 85 743 74 17, 85 878 16 10 wew. 102
e-mail: medycyna@optec.pl





Laryngologia

Nasal operating forceps



Detachable suction polyp forceps, 0°
B 2162.1 \varnothing 5 x 140mm
B 2162.2 \varnothing 4 x 140mm
B 2162.3 \varnothing 3 x 140mm



B 2030 Nasal stamping forceps
(180mm)



B 1001 Adult nasal speculum
(30mm)

B 1002 Pediatric nasal speculum
(20mm)



Adult nasal speculum
B 1001.2 30mm, Right-curved
B 1001.3 30mm, Left-curved



B 1003 Operation nasal speculum
(50mm)

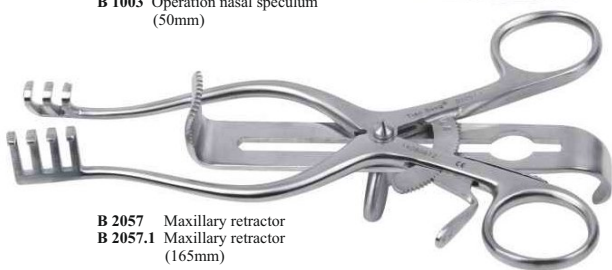

B 2057 Maxillary retractor
B 2057.1 Maxillary retractor
(165mm)



B 2071 Nasal bone resetting forceps

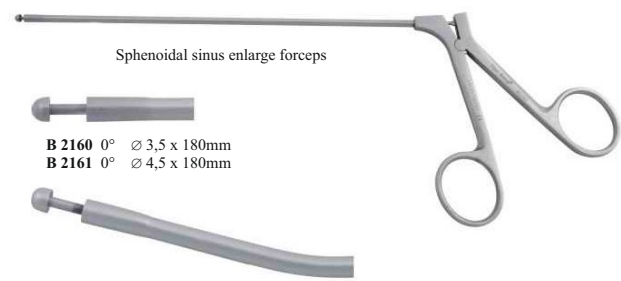

Sphenoidal sinus enlarge forceps

B 2160 0° \varnothing 3,5 x 180mm
B 2161 0° \varnothing 4,5 x 180mm

B 2160.1 30° \varnothing 3,5 x 180mm
B 2161.1 30° \varnothing 4,5 x 180mm

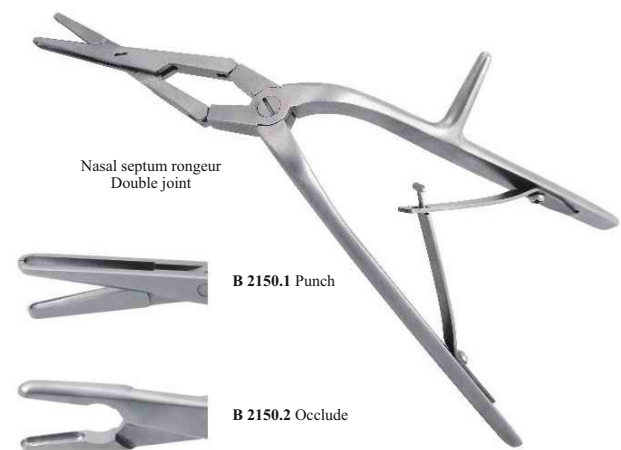

Nasal septum rongeur
Double joint



B 2150.1 Punch



B 2150.2 Occlude



B 2032 Nasal mouth gag



B 2024 Nasal polyp snare

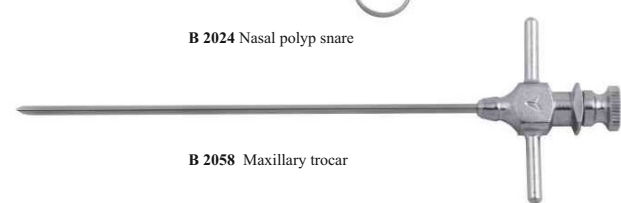

B 2058 Maxillary trocar

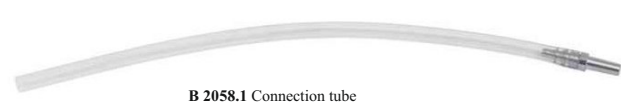

B 2058.1 Connection tube





Laryngologia



Nasal instruments



B 2031 Nasal mucosa knife



Sinus curette, without hole
B 2044.1 (L)
B 2044.2 (M)
B 2044.3 (S)



Sinus curette, with hole 0°
B 2045.1 (L)
B 2045.2 (M)
B 2045.3 (S)



Sinus curette, with hole 15°
B 2046.1 (L)
B 2046.2 (M)
B 2046.3 (S)



Sinus curette, with hole 30°
B 2047.1 (L)
B 2047.2 (M)
B 2047.3 (S)



Sinus curette, without hole 45°
B 2048.1 (L)
B 2048.2 (M)
B 2048.3 (S)



Sinus curette, without hole 90°
B 2049.1 (L)
B 2049.2 (M)
B 2049.3 (S)



B 2049.4 Sinus curette 45°



Nasal cutting curette 190mm
B 2089 Forward
B 2090 Backward



B 2112 Sinus curette, with hole



B 2113 Sinus curette, without hole



B 2061 (0°) Nasal septum elevator



Nasal septum elevator
B 2062 15°
B 2063 30°



B 2062.1 (15°) Nasal septum elevator
 Long flat handle



Nasal septum elevator
B 2062.2 0° Long flat handle
B 2065 90° Upward flat, tip



B 2064 (45°) Nasal septum elevator
 Upward, triangular head



B 2066 Nasal septum elevator
 Round head



B 2017 Nasal septum elevator



Elevator
B 2503 Double heads, curved
B 2503.1 One side straight, another side curved



B 2506 (∅ 3x75mm)
 Nasal bone chisel
 Flat head



B 2508 (70°/∅ 2x3mm)
 Cerumen hook
 Flat wide head, curved



B 2507 Nasal probe ∅ 2,5mm
 Round head, curved



Nasal septum elevator
B 2067 Double heads, curved
B 2067.1 One side straight, another side curved
B 2067.4 70mm



B 2504 Small sinus curette
 Double head



B 2067.2 Nasal foreign body hook & ring



B 2067.3 Nasal septum elevator
 (Half round knife, double heads)



B 2083 Nasal septum elevator
 Double head, curved
B 2083.1 Small



B 2505 Sinus operation knife, Double heads



B 2084 Nasal septum elevator
 Double head, straight



B 2608 Nasal septum elevator
 One side elevator, the other side hook

Optec s.c.

ul. Alberta 6E, 16-001 Ksieżyno k. Białegostoku
 tel. 85 743 74 17, 85 878 16 10 wew. 102
 e-mail: medycyna@optec.pl





Laryngologia

Nasal instruments

Elewator suction tube

B 2502.1 ∅ 3,5 x 75mm
B 2502.6 ∅ 3,5 x 145
B 2502.11 ∅ 3,5 x 75mm 360°
 Suction head 360° rotatable

B 2502.2 ∅ 2,5 x 60mm
B 2502.10 ∅ 2,5 x 60mm 360°
 Suction head 360° rotatable

B 2502.14 0° Nasal elevator ∅ 2,5 x 80mm
 One side hole, rotatable

B 2502.20 45° Nasal elevator ∅ 2,5 x 80mm
 Two sides hole, rotatable

B 2505.4 Nasal elevator, double heads: one knife, one elevator

B 2604 2x6x90° Nasal curet

B 2607 Probe, Double heads lenght 190, head ∅ 2 , ∅ 1,4

B 2607.1 Probe, Double heads ∅ 1,6, lenght 210 , one end hooked

Nasal curet, Suction
B 2602 ∅ 2,5 x 90°
B 2602.1 ∅ 2,5 x 60°
B 2602.2 ∅ 2,5 x 45°
B 2602.3 ∅ 2,5 x 40°

Nasal septum fish tail chisel, straight
B 2059.1 (L)
B 2059.2 (M)
B 2059.3 (S)

Nasal septum fish tail chisel, bayonet shaped
B 2060.1 (L)
B 2060.2 (M)
B 2060.3 (S)

Nasal bone chisel
B 2075 Nasal bone chisel,
 Flat, curved

Double protection
B 2072.1 6mm
B 2072.2 8mm

Left protection
B 2073.1 6mm
B 2073.2 8mm

Right protection
B 2074.1 6mm
B 2074.2 8mm

B 2076 Nasal bone chisel,
 Boyonet shaped, half round





Laryngologia



Nasal instruments



Nasal septum swivel knife, straight

- B 2068.1** 3mm
- B 2068.2** 4mm
- B 2068.3** 5mm

Nasal septum swivel knife, tip, straight

- B 2068.4** 3mm
- B 2068.5** 4mm
- B 2068.6** 5mm



Nasal septum swivel knife, bayonet

- B 2069.1** 3mm
- B 2069.2** 4mm
- B 2069.3** 5mm



Barnhill adenoid curette, without hook

- B 2091.1** (L)
- B 2091.2** (M)
- B 2091.3** (S)



Barnhill adenoid curette, with hook

- B 2092.1** (L)
- B 2092.2** (M)
- B 2092.3** (S)



B 2031.1 (190mm) Nasal cartilage knife, double heads



B 2070 Nasal bone restorer

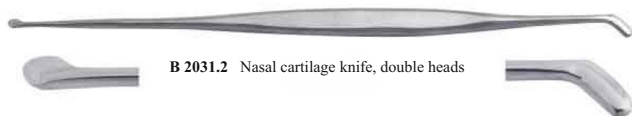

B 2031.2 Nasal cartilage knife, double heads



B 2070.1 Nasal bone restorer



B 2163 (180mm)
Maxillary retractor
Double heads



B 2127 Nasal raps, double sides rasp
6 x 42mm



Sickle knife



B 2120 Trocar
∅ 4,2 x 100mm



B 2118 Sharp head curved



B 2119 Blunt head curved



B 2120.2 Trocar
∅ 5 x 50mm



B 2220 Nasal probe



B 2121 Endoscope holder



B 2077 Nosepiece scissors
Upperbound



B 2078 Nosepiece scissors
Middlebound



B 2079 Nosepiece scissors
Lowerbound

Optec s.c.

ul. Alberta 6E, 16-001 Księżyno k. Białegostoku
tel. 85 743 74 17, 85 878 16 10 wew. 102
e-mail: medycyna@optec.pl





Laryngologia

Nasal suction tube

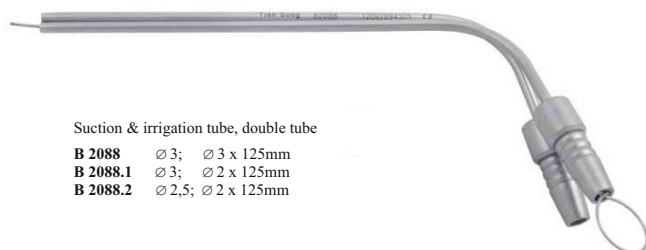

Suction & irrigation tube, double tube

- B 2088** ∅ 3; ∅ 3 x 125mm
- B 2088.1** ∅ 3; ∅ 2 x 125mm
- B 2088.2** ∅ 2,5; ∅ 2 x 125mm



Maxillary suction tube

- B 2115A** ∅ 3 x 125mm
- B 2115** ∅ 3 x 140mm
- B 2115.1** ∅ 4 x 140mm
- B 2115.2** ∅ 2,5 x 140mm
- B 2169** ∅ 3 x 140mm Curved flexible
- B 2169.1** ∅ 4 x 140mm Curved flexible



Maxillary suction tube, straight

- B 2015.3** ∅ 3 x 125mm
- B 2015.6** ∅ 4 x 125mm
- B 2015.15** ∅ 2,5 x 125mm
- B 2016.4** ∅ 4 x 175mm
- B 2016.5** ∅ 3 x 175mm
- B 2016.6** ∅ 2,5 x 175mm
- B 2167.1** ∅ 3 x 175mm, Flexible



Maxillary suction tube

- B 2115.5** Straight handle ∅ 3 x 125mm
- B 2115.13** ∅ 4 x 125mm
- B 2115.21** ∅ 2,5 x 125mm



Maxillary suction tube

- B 2115.7** ∅ 4 x 125mm Curved, square handle
- B 2115.12** ∅ 2,5 x 125mm
- B 2115.14** ∅ 3,5 x 125mm
- B 2115.4** ∅ 3 x 125mm



Maxillary suction tube, square handle

- B 2115.16** ∅ 2,5 x 110mm Straight
- B 2115.17** ∅ 3 x 110mm Straight
- B 2115.18** ∅ 4 x 110mm Straight

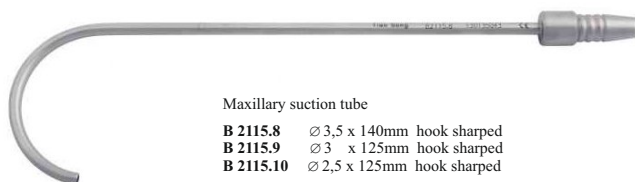

Maxillary suction tube

- B 2115.8** ∅ 3,5 x 140mm hook sharpened
- B 2115.9** ∅ 3 x 125mm hook sharpened
- B 2115.10** ∅ 2,5 x 125mm hook sharpened

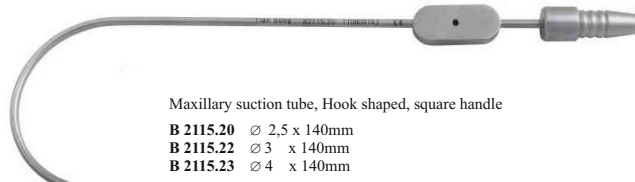

Maxillary suction tube, Hook shaped, square handle

- B 2115.20** ∅ 2,5 x 140mm
- B 2115.22** ∅ 3 x 140mm
- B 2115.23** ∅ 4 x 140mm



B 2115.25 Suction tube
∅ 2,5 x 110mm
Long handle, with adaptor

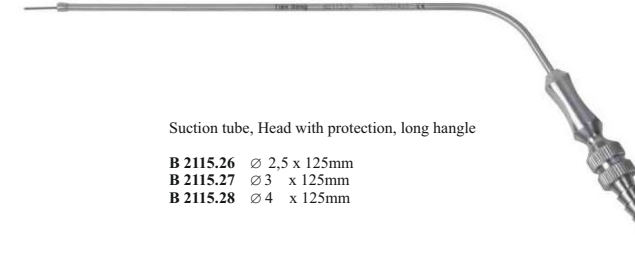

Suction tube, Head with protection, long handle

- B 2115.26** ∅ 2,5 x 125mm
- B 2115.27** ∅ 3 x 125mm
- B 2115.28** ∅ 4 x 125mm

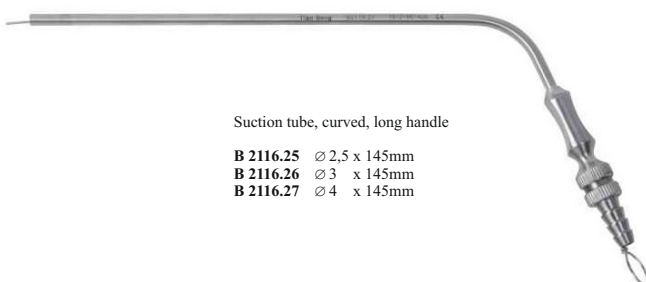

Suction tube, curved, long handle

- B 2116.25** ∅ 2,5 x 145mm
- B 2116.26** ∅ 3 x 145mm
- B 2116.27** ∅ 4 x 145mm

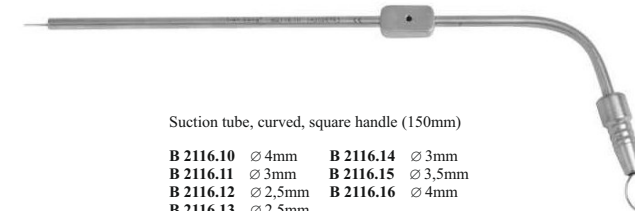

Suction tube, curved, square handle (150mm)

- B 2116.10** ∅ 4mm
- B 2116.11** ∅ 3mm
- B 2116.12** ∅ 2,5mm
- B 2116.13** ∅ 2,5mm
- B 2116.14** ∅ 3mm
- B 2116.15** ∅ 3,5mm
- B 2116.16** ∅ 4mm





Laryngologia



Nasal suction tube

Suction tube, curved 175mm

- B 2116 \varnothing 3,5mm
- B 2116.1 \varnothing 4mm
- B 2116.2 \varnothing 3mm
- B 2116.3 \varnothing 2,5mm
- B 2166 \varnothing 4mm
- B 2167 \varnothing 3mm
- B 2168 \varnothing 2,5mm



Suction tube

- B 2116.20 \varnothing 3 x 145mm
- B 2116.21 \varnothing 3 x 130mm



Suction tube, curved, long handle 175mm

- B 2116.7 \varnothing 4mm
- B 2116.8 \varnothing 2mm
- B 2116.9 \varnothing 2,5mm

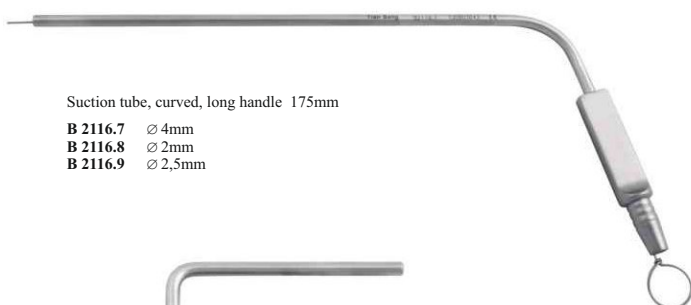

Elevator, with suction

- B 2117.1 \varnothing 3mm
- B 2117.2 \varnothing 4mm



Adaptor, for suction tube

- B 2170 For long connector
- B 2171 For short connector
- B 2172 For peanut connector

B 2510 (\varnothing 2 x 180mm)
Nasal irrigation tube, curved

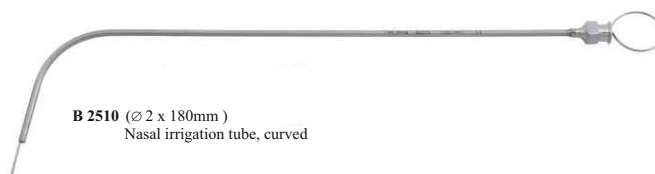

Suction tube for treatment table, long connector

- B 2170.1 \varnothing 1,5mm
- B 2170.2 \varnothing 2mm
- B 2170.3 \varnothing 2,5mm
- B 2170.4 \varnothing 3mm
- B 2170.5 \varnothing 3,5mm

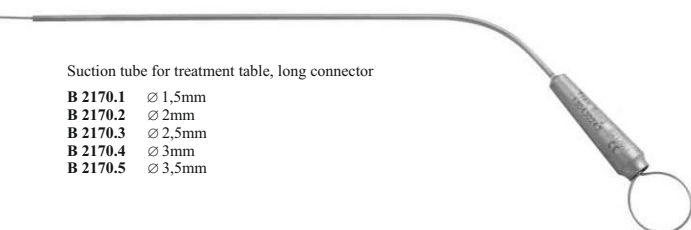

Suction tube for treatment table
short connector

- B 2171.1 \varnothing 1,5mm
- B 2171.2 \varnothing 2mm
- B 2171.3 \varnothing 2,5mm
- B 2171.4 \varnothing 3mm
- B 2171.5 \varnothing 3,5mm

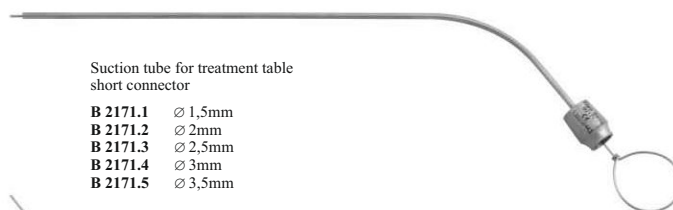

Suction tube for treatment table
peanut connector, S type

- B 2173.1 \varnothing 1,5mm
- B 2173.2 \varnothing 2mm
- B 2173.3 \varnothing 2,5mm
- B 2173.4 \varnothing 3mm
- B 2173.5 \varnothing 3,5mm

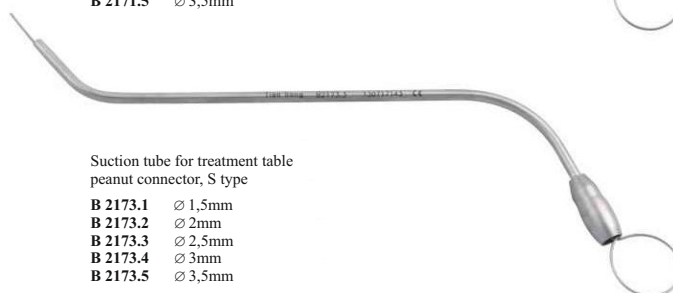

Suction tube for treatment table, long connector

- B 2172.1 \varnothing 1,5mm
- B 2172.2 \varnothing 2mm
- B 2172.3 \varnothing 2,5mm
- B 2172.4 \varnothing 3mm
- B 2172.5 \varnothing 3,5mm

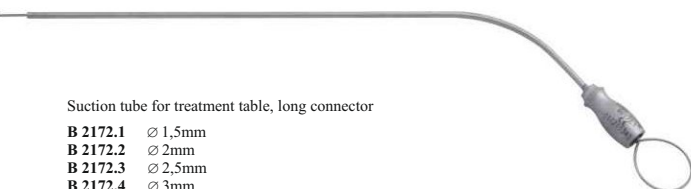

Nasal suction adaptor olive head

- B 2174.1 \varnothing 12
- B 2174.2 \varnothing 13
- B 2174.3 \varnothing 14

Nasal mastoid suction tube, straight (\varnothing 5x195mm)

- B 2511.1 \varnothing 5mm
- B 2511.2 \varnothing 4mm
- B 2511.3 \varnothing 3mm
- B 2511.4 \varnothing 4,5 x 195mm
- B 2511.5 \varnothing 3,5 x 195mm
- B 2511.7 \varnothing 4 x 195mm
- B 2511.15 \varnothing 2,5 x 195mm



Nasal mastoid suction tube, curved (\varnothing 5 x 195mm)

- B 2512.1 \varnothing 5mm 90°
- B 2512.2 \varnothing 4mm
- B 2512.3 \varnothing 3mm
- B 2512.4 \varnothing 4 x 195mm
- B 2512.6 \varnothing 5 x 195mm 90°
- B 2512.7 \varnothing 3,5 x 195mm
- B 2512.8 \varnothing 3 x 195mm





Laryngologia

Pediatric nasal instruments



B 2201



B 2203

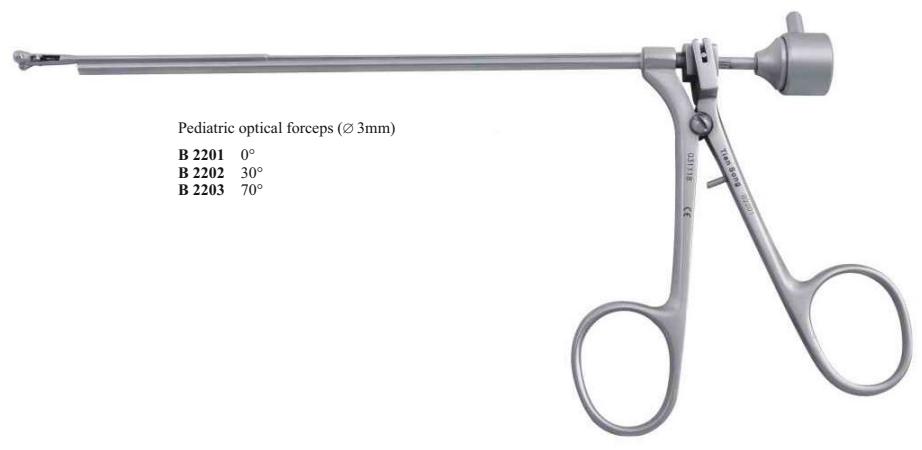

Pediatric optical forceps (∅ 3mm)

- B 2201** 0°
- B 2202** 30°
- B 2203** 70°



B 2205 Straight



B 2207 Right curved

B 2206 Left curved



Tissue forceps of nasal cavity
B 2039.2 0°
B 2040.2 30°
B 2041.2 45°
B 2042.2 90°



B 2094.3 0° Cutting forceps of nasal ethmoid (S)



B 2094.4 30° Cutting forceps of nasal ethmoid (S)



B 2209 0°/95mm
Tissue forceps of nasal cavity, Sharp head 0°



B 2210 30°/95mm
Tissue forceps of nasal cavity, Sharp head 30°



B 2211 45°/95mm
Tissue forceps of nasal cavity, Sharp head 45°



B 2212 90°/95mm
Tissue forceps of nasal cavity, Sharp head 90°

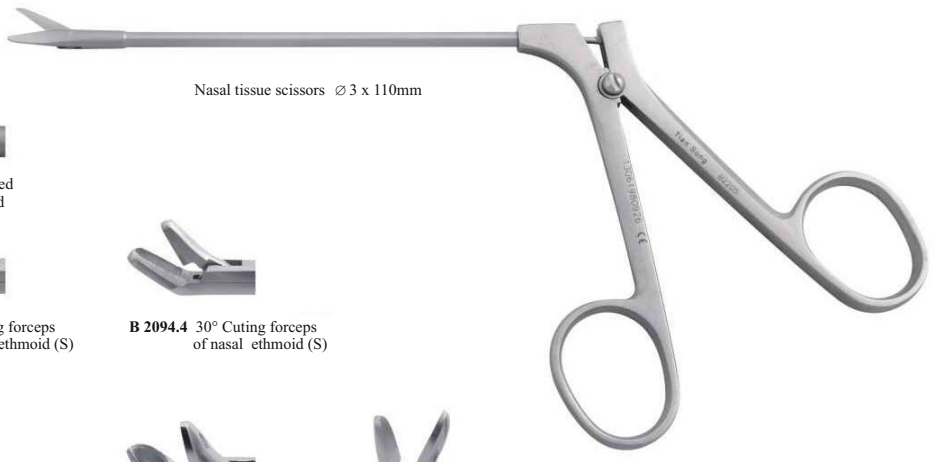

Nasal tissue scissors ∅ 3 x 110mm



B 2208 95mm Sinus rongeur, back-biting



B 2213 0° Tissue forceps of nasal cavity, round head



B 2214 30° Tissue forceps of nasal cavity, round head





Laryngologia



BD-7 Nasal power drill

B 5001 Control Unit

B 5002 Foot pedal

B 3007 Handpiece

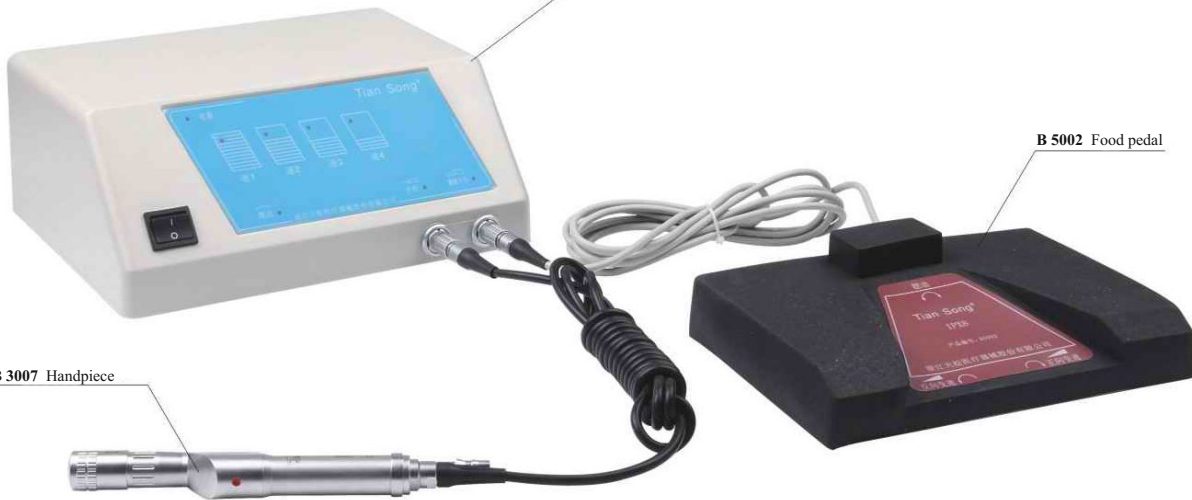

Cutting blade



B 3005.1 \varnothing 4mm
Oblique with tooth



B 3005.2 \varnothing 4mm
Oblique without tooth



B 3005.3 \varnothing 4mm
Flat with tooth
inside & outside



B 3005.4 \varnothing 4mm
Ball shaped



B 3005.23 \varnothing 4,5mm
Oblique with tooth



B 3005.24 \varnothing 4,5mm
Oblique without tooth



B 3005.25 \varnothing 4,5mm
Flat with tooth
inside & outside



Cutting blade



Oblique without tooth on obverse side, \varnothing 4,5mm
B 3005.5 20°
B 3005.7 40°
B 3005.9 60°
B 3005.11 75°
B 3005.13 20° \varnothing 4,0mm



Oblique without tooth on obverse side \varnothing 4,5mm
B 3005.6 20°
B 3005.8 40°
B 3005.10 60°
B 3005.12 75°
B 3005.14 20° \varnothing 4,0mm



B 3003 Irrigation head

Optec s.c.

ul. Alberta 6E, 16-001 Księżyno k. Białegostoku
tel. 85 743 74 17, 85 878 16 10 wew. 102
e-mail: medycyna@optec.pl





Laryngologia

BD-9 Nasal power drill



Cutting blade, srtraight (with irrigation)



B 3103.2 Oblique with tooth, irrigation



B 3104.2 Oblique without tooth, irrigation



B 3105.2 With tooth inside and outside, irrigation



B 3106.1 \varnothing 4,0mm Ball shaped



Oblique with tooth on obverse side \varnothing 4,5mm
B 3107.1 20°
B 3109.1 40°
B 3111.1 60°



Oblique with tooth on obverse side \varnothing 4,5mm
B 3108.1 20°
B 3110.1 40°
B 3112.1 60°





Laryngologia



Nasal electric coagulator with suction



Elevator suction tube, use with M1020
B 2501 ∅ 4 x 100mm
B 2501.1 ∅ 3,5 x 100mm



Nasal electric coagulator with suction, flat use with M1002
B 2122 ∅ 3mm
B 2122.4 ∅ 4mm



B 2122.8 Nasal electric coagulator with suction
 Slightly curved ∅ 3,4 x 130mm



Nasal electric coagulator with suction, flat, bipolar use with B 1006
 (0°/170mm/B 1006)
B 2124 ∅ 4mm
B 2124.3 ∅ 3mm
B 2124.5 ∅ 5mm



Nasal electric coagulator with suction, flat, bipolar use with B 1006
 (0°/170mm/B 1006)
B 2124.1 ∅ 4mm 15°
B 2124.4 ∅ 3mm 15°
B 2124.7 ∅ 5mm 15°

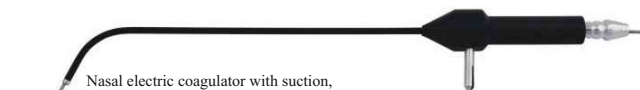

Nasal electric coagulator with suction,
 flat use with M1002 Flat
B 2122.2 ∅ 3mm 60°
B 2122.3 ∅ 3mm 90°
B 2122.6 ∅ 4mm 60°
B 2122.7 ∅ 4mm 90°



Nasal electric coagulator with suction, flat use with M1002
B 2122.1 ∅ 3mm 50°
B 2122.5 ∅ 4mm 50°
B 2123.1 ∅ 3mm 45°
B 2123.2 ∅ 4mm 45°

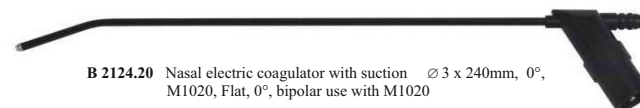

B 2124.20 Nasal electric coagulator with suction ∅ 3 x 240mm, 0°,
 M1020, Flat, 0°, bipolar use with M1020



Nasal electric coagulator with suction, flat, bipolar, curved use with B1006
B 2124.2 ∅ 4mm 45°
B 2124.6 ∅ 5mm 45°

Nasofaryngoskop



240.00121.00 Nasofaryngoskop FNS-2800
 Working length: 300mm
 Working diameter: 2.8mm
 Viewing angle: 85°
 Articulation up/down 150°

240.00120.00 Nasofaryngoskop FNS-3400
 Working length: 300mm
 Working diameter: 3.4mm
 Viewing angle: 85°
 Articulation up/down 150°





Laryngologia

Laryngoscope

- 1. Connecting to TIANSONG light guide cable
- Connecting to OLYMPUS light guide cable
- Connecting to STORZ light guide cable
- 2. Connecting to WOLF light guide cable
- 3. Connecting to ACMI, STRYKER light guide cable



D 0101 90°, Ø 8 x 175mm



Side viewing Laryngoscope
D 0104.1 70°, Ø 8 x 170mm
D 0112 70°, Ø 8 x 170mm
134°C 2 bar Autoclave



Tele - laryngoscope
D 0102 90°, Ø 8 x 174mm
D 0103 70°, Ø 8 x 178mm
D 0110 70°, Ø 8 x 175mm



Side viewing Laryngoscope
D 0116.1 12°, Ø 4 x 185mm
D 0117.1 0°, Ø 4 x 183mm



D 0105 70°, Ø 5 x 175mm
D 0105.1 70°, Ø 5 x 175mm
134°C 2 bar Autoclave



Side viewing Laryngoscope
D 0116 12°, Ø 4 x 185mm
D 0117 0°, Ø 4 x 183mm





Laryngologia



Self-retaining laryngoscopy set

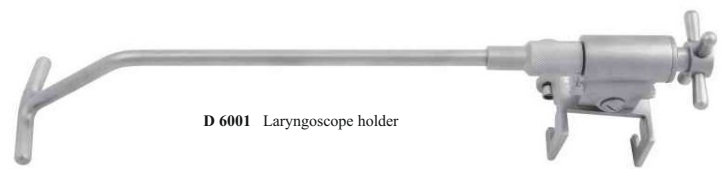

D 6001 Laryngoscope holder



Light guide cable
 Screw adaptor
D 1050 \varnothing 2,5 x 1700mm
J 5010 \varnothing 1,8 x 1700mm
 Click adaptor
T 5013 \varnothing 1,8 x 1700mm
T 5014 \varnothing 2,5 x 1700mm

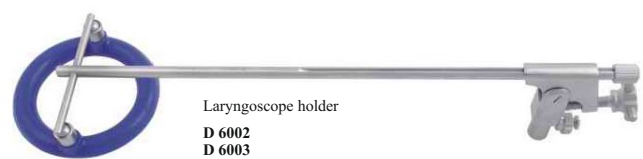

Laryngoscope holder
D 6002
D 6003
D 1003
D 1004



D 6005 Laryngoscope holder

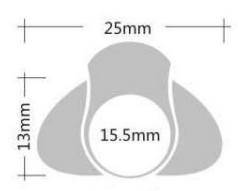

Oval (L)

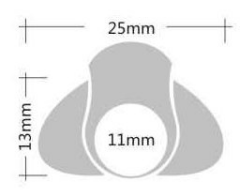

Oval (S)

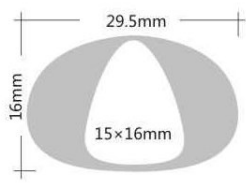

Triangle (L)

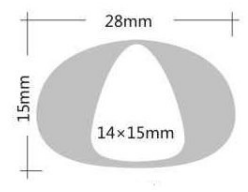

Triangle (S)



Expanding laryngoscope tube
D 1016
D 5020.1
 For side viewing laryngoscope
D 1017 12°



Laryngoscope tube, for D2083
D 1001 (L) 170mm
D 1002 (S) 170mm



Laryngoscope tube
D 1003 (L) 175mm
D 1004 (S) 175mm



Laryngoscope tube
D 1011 (L) 175mm
D 1012 (S) 175mm



Laryngoscope tube for 12° endoscope
D 1013.1 (L) 175mm
D 1014.1 (S) 175mm



Laryngoscope tube for 0° endoscope
D 1013 (L) 175mm
D 1014 (S) 175mm



Laryngoscope tube (D 5020.1)
D 2101 (L) 150mm
D 2102 (S) 130mm



Laryngoscope tube
D 2103 (L) 11 x 150mm
D 2104 (S) 11 x 130mm



Direct laryngoscope tube
D 2076.1 (L) 16 x 175mm
D 2076.2 (M) 14 x 175mm
D 2076.3 (S) 12 x 175mm



Lateral laryngoscope tube
D 2077.1 (L) 16 x 175mm
D 2077.2 (M) 14 x 150mm
D 2077.3 (S) 12 x 100mm





Laryngeal operating forceps

D 2001 Micro-laryngeal forceps, straight	D 2002 30° Micro-laryngeal forceps	D 2003 Left-curved 30° D 2004 Right-curved 30°		D 2005 45° Micro-laryngeal forceps, with tooth 45°	D 2006 Micro-laryngeal forceps, cutting
D 2007 Micro-laryngeal forceps, biopsy	D 2008 Micro-laryngeal forceps, barb tooth	D 2009 Micro-laryngeal forceps, grasping	D 2010 0° Micro-laryngeal forceps, triangular head	D 2011 45° Micro-laryngeal forceps, triangular head	
D 2012 Micro-laryngeal scissors, straight	D 2013 Left curved D 2014 Right curved		D 2015 15° Micro-laryngeal scissors	D 2016 45° Micro-laryngeal scissors	D 2017 45° Micro-polyp forceps, open to left
D 2019 Left fish-mouth D 2020 Right fish-mouth		D 3011 Micro-laryngeal forceps, straight ∅2x230mm	D 3012 30° Micro-laryngeal forceps ∅2x230mm	D 3013 Micro-laryngeal forceps, left-curved ∅2x230mm	D 3014 Micro-laryngeal forceps, right-curved ∅2x230mm
D 3018 0° Micro-laryngeal forceps, triangular head ∅2x230mm	D 3019 45° Micro-laryngeal forceps, triangular head ∅2x230mm	D 3020 0° Micro-laryngeal forceps, triangular head, with tooth ∅2x230mm, 0° D 3020.1 ∅2x230mm, 45°	D 3021 ∅2x230mm D 3022 ∅2x230mm, 0° D 3023 ∅2x230mm, 45°		
Direct laryngeal forceps 230mm					
D 2045 Crocodile head	D 2048 45° Upward	D 2046 Left kidney shaped D 2047 Right kidney shaped		D 2049 Triangular head	
D 2050 45° Upward/Triangular head	D 2051 Cup head	D 2085.1 ∅ 5mm D 2085.2 ∅ 4mm D 2085.3 ∅ 3mm			
Laryngeal foreign body forceps					
D 3001 270mm open to up D 3002 270mm open to down D 3003 270mm open to left D 3004 270mm open to right		D 3005 45° 250mm Head upward 45°, Cup head	D 3006 45° 250mm Head upward 45° D 3006.1 15°, 45° 250mm Stick up-curved 15°, Head upward 45°	D 3006.3 45° 250mm Head upward 45°, Triangle	



Laryngologia



Laryngeal operating forceps



D 2070 (260mm) Indirect laryngeal forceps
On a handle with three jaws,
rotating head



Polyp forceps of vocal cord,
260mm

- D 2021** Rotating head
- D 2022** Open to front
- D 2023** Open to back
- D 2024** Open to left
- D 2025** Open to right



Special polyp forceps
of vocal cord, 45° 260mm

- D 2026** Open to front
- D 2027** Open to back
- D 2028** Open to left
- D 2029** Open to right



Special laryngeal forceps
260mm

- D 2030** Rotating head
- D 2031** Upward
- D 2032** Downward
- D 2033** Leftward
- D 2034** Rightward



Fish bone catching forceps,
260mm

- D 2035** Open to front
- D 2036** Open to left
- D 2037** Open to right
- D 2038** Open to back
- D 2039** Rotating head
- D 2040** Open to left & right



D 2041 Laryngeal scissors



D 2042 260mm
Laryngeal pustule cutting
forceps, open to left & right

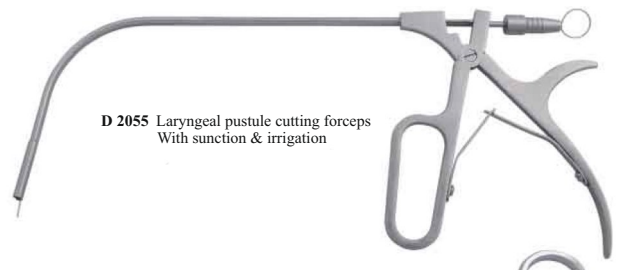

D 2055 Laryngeal pustule cutting forceps
With suction & irrigation



Fish bone catching forceps, new type (260mm)

- D 2040.1** Curved, open to up
- D 2040.2** Open to left
- D 2040.3**



Indirect laryngeal forceps

- D 2071** Open to left
- D 2072** Open to right
- D 2073** Open to up
- D 2074** Open to down



Indirect laryngeal forceps

- D 2071.1** Open to left
- D 2072.1** Open to right
- D 2073.1** Open to up
- D 2074.1** Open to down



D 2058.1 6,5x17mm
Tonsil forceps



D 2058.2 5,5x15mm
Tonsil forceps



D 1009.1 112mm
Laryngoscope blade



D 1010.1 132mm
Laryngoscope blade



D 1009.2 100mm
Laryngoscope blade



D 1010.2 130mm
Laryngoscope blade



D 1008.1 92mm
Laryngoscope blade



D 1008.2 92mm
Laryngoscope blade



D 1007.1 77mm
Laryngoscope blade



D 1007.2 80mm
Laryngoscope blade

MYJ-2 Anesthetic laryngoscope,
fiber optic

T 5007.2 130mm
Minitype light source

MYJ-3 Anesthetic laryngoscope,
with lamp





Laryngologia

Laryngeal instruments



D 2057 Tonsil gland scissors



Tonsil holding forceps (220mm)
D 2058 Angled with 3 claws
D 2059 Angled with teeth



Tonsil hemostat (180mm)
D 2060 Micro curved
D 2061 Angled curved
D 2060.1 Micro curved 200mm



Tonsil sponge forceps (180mm)
D 2062 Straight groove
D 2063 Curved groove
D 2062.1 Straight without groove
D 2063.1 Curved without groove
D 2062.4 250mm, Straight without groove
D 2063.4 250mm, Curved without groove



D 2068 180mm Thyroid scissors

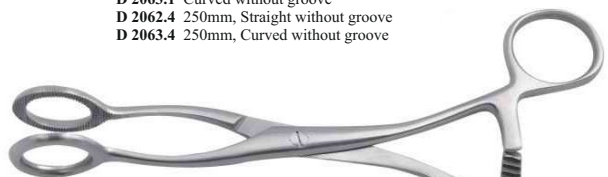

D 2089 170mm, Tongue grasping forceps



D 2064 Tonsil elevator



D 2067 Tonsil retractor, elevator, double heads



Tonsil retractor
D 2065 2 claw, blunt head
D 2065.1 2 claw, sharp head



D 2066 Tonsil knife



D 2066.1 Tonsil knife



D 2078 (250mm) Laryngotome



D 2079 (250mm) Laryngeal needle



D 2080 (250mm) Laryngeal hook

D 2081 (250mm) Handle



D 2097 (230mm) B1006
Laryngeal electric coagulator
with suction bipolar,
flat \varnothing 5 x 240mm/45°



Laryngeal electric coagulator, with suction
M1002
D 2093.1 \varnothing 3,5mm
D 2093.2 \varnothing 2,5mm
D 2093.3 \varnothing 2mm



Laryngeal electric hook M1002
D 2094.1 \varnothing 3,5mm
D 2094.2 \varnothing 2,5mm





Laryngologia



Laryngeal instruments

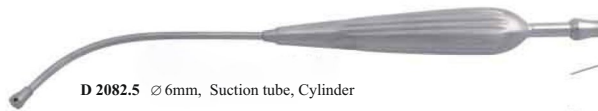

D 2082.5 \varnothing 6mm, Suction tube, Cylinder

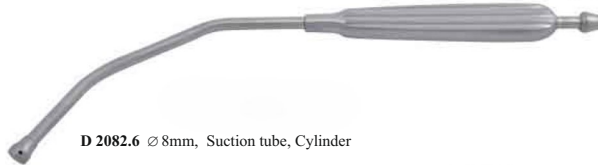

D 2082.6 \varnothing 8mm, Suction tube, Cylinder

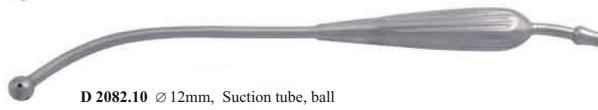

D 2082.10 \varnothing 12mm, Suction tube, ball



Suction tube 250mm
D 2082.1 \varnothing 4mm
D 2082.2 \varnothing 3mm
D 2082.3 \varnothing 2,5mm



D 2095 Thyroid retractor, double heads



D 2083 (\varnothing 3,6 x 200mm) Lamp-wick



D 5020.1 \varnothing 3mm Lamp-wick
D 5020.2 Lamp-wick



D 5020.4 D 1017 Lamp-wick



D 2043 Laryngeal polyp snare



Adenoidecctome, cassette
D 2086.1 (L)
D 2086.2 (M)
D 2086.3 (S)

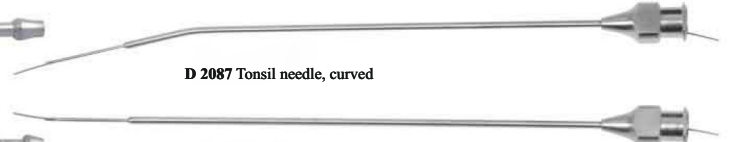

D 2087 Tonsil needle, curved



D 2088 Tonsil needle, straight



D 2044 Tonsil guillotine, three heads



Tonsil guillotine, with protection
D 2044.1 (M)
D 2044.2 (S)
D 2044.3 (L)

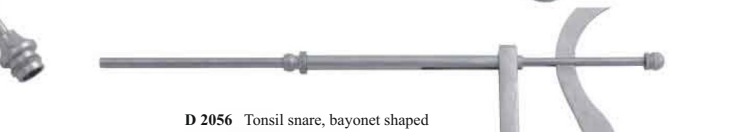

D 2056 Tonsil snare, bayonet shaped



Tonsil wire
K 6001.3 \varnothing 0,4mm/2mm /D 2043
K 6001.4 \varnothing 0,45mm/2mm /D 2056

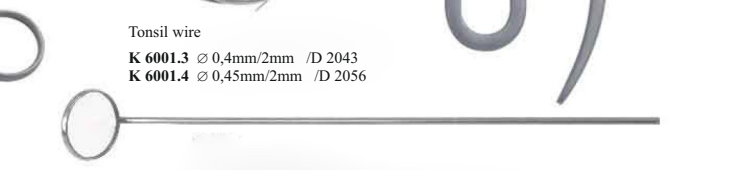

Pharyngoscope
D1015.1 12mm,19cm D1015.3 16mm,19cm D1015.5 20mm,19cm D1015.7 24mm,19cm
D1015.2 14mm,19cm D1015.4 18mm,19cm D1015.6 22mm,19cm

Optec s.c.

ul. Alberta 6E, 16-001 Ksieżyno k. Białegostoku
tel. 85 743 74 17, 85 878 16 10 wew. 102

e-mail: medycyna@optec.pl





Laryngologia

Laryngeal instruments



Mouth- gag



D 2052 (5x1)



D 2052.1 (4x1)



D 2052.2 (5x1)



D 2052.3 (4x1)



D 2053 (5x1)
With water nozzle



D 2053.1 (5x1)
With fiber



D 2053.2 (5x1)

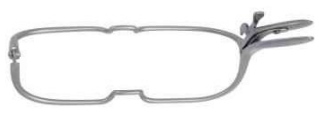

Mouth-gag
D 2075 (L)
D 2075.1 (M)
D 2075.2 (S)



D 2053.4 (5x1)



D 2053.3 (4x1)
Mouth-gag, Frame

Bronchoscopy instruments

Endoscope \varnothing 3 x 358mm
J 0210 0°

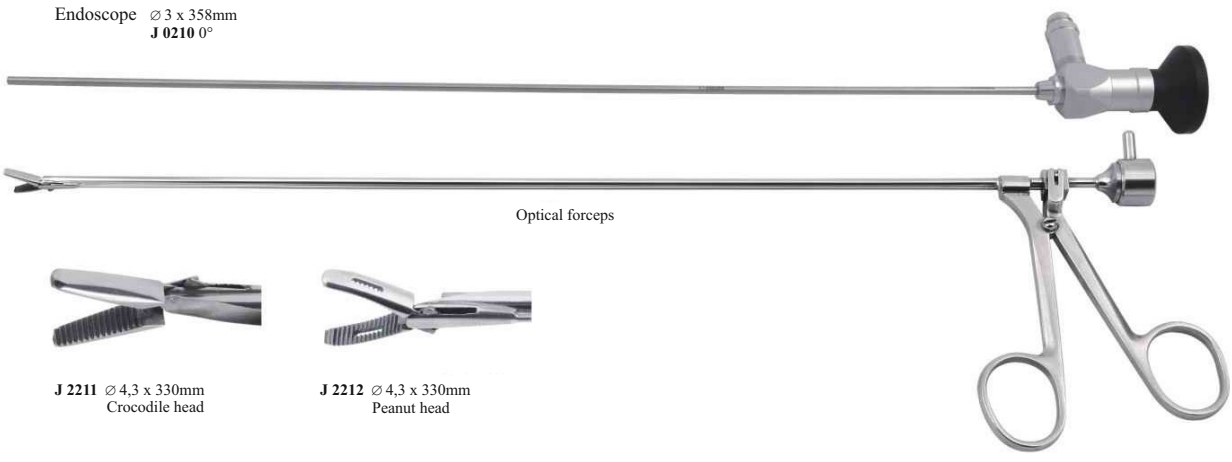

Optical forceps



J 2211 \varnothing 4,3 x 330mm
Crocodile head



J 2212 \varnothing 4,3 x 330mm
Peanut head





Laryngologia



Bronchoscopy instruments

Pediatric bronchoscope tube

- J 1006 \varnothing 4,2 x 250mm
- J 1007 \varnothing 4,6 x 250mm
- J 1008 \varnothing 5,2 x 260mm
- J 1009 \varnothing 5,6 x 260mm
- J 1010 \varnothing 6,3 x 260mm

- J 1001 \varnothing 3,5 x 200mm
- J 1002 \varnothing 4 x 200mm
- J 1003 \varnothing 4,5 x 250mm
- J 1004 \varnothing 5 x 300mm
- J 1005 \varnothing 5,5 x 350mm

Fibers inside for illumination

- J 1011 \varnothing 4 x 260mm
- J 1012 \varnothing 4,5 x 280mm
- J 1013 \varnothing 5 x 280mm
- J 1014 \varnothing 5,5 x 280mm
- J 1015 \varnothing 6 x 300mm

Adult bronchoscope tube

- J 1016 \varnothing 6,5 x 350mm
- J 1017 \varnothing 7 x 400mm

- J 1021 \varnothing 4 x 260mm
- J 1022 \varnothing 4,5 x 280mm
- J 1023 \varnothing 5 x 280mm
- J 1024 \varnothing 5,5 x 280mm
- J 1025 \varnothing 6 x 300mm

J 5001 90° Prismatic light deflector

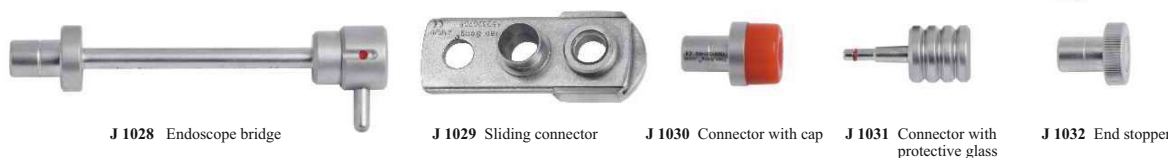

J 1028 Endoscope bridge

J 1029 Sliding connector

J 1030 Connector with cap

J 1031 Connector with protective glass

J 1032 End stopper

\varnothing 1,8 x 360mm Foreign body forceps



J 2001 Saw-toothed head
J 2001.1 \varnothing 1,8 x 460mm

J 2001.2 New Saw-toothed head

J 2002 Ring head

J 2003 Cup head

J 2003.2 New Cup head

J 2006 Triticeus head
J 2006.1 \varnothing 1,8 x 460mm

J 2006.2 New Triticeus head

J 2007 Crocodile head
J 2007.1 \varnothing 1,8 x 460mm

J 2007.2 New Crocodile head

J 2008 Pen-sheath-carrying
 \varnothing 1,8 x 360mm

J 2010 Ball-carrying

J 2010.2 New Ball-carrying
J 2010.4 \varnothing 1,8 x 460mm

J 2011 Sharp head

J 2010.1 Ball-carrying serrated

Optec s.c.

ul. Alberta 6E, 16-001 Ksieżyno k. Białegostoku
tel. 85 743 74 17, 85 878 16 10 wew. 102
e-mail: medycyna@optec.pl





Laryngologia

Bronchoscopy instruments

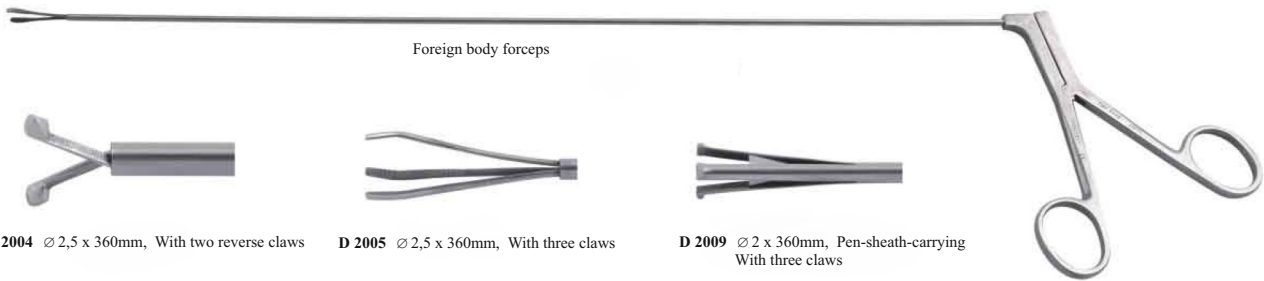

Foreign body forceps

D 2004 ∅ 2,5 x 360mm, With two reverse claws

D 2005 ∅ 2,5 x 360mm, With three claws

D 2009 ∅ 2 x 360mm, Pen-sheath-carrying
With three claws



D 2012 ∅ 2,5 x 360mm, With two claws



D 2013 ∅ 2,5 x 360mm, Ring sharpened



D 2014 ∅ 2,5 x 360mm, Front claw



D 2015 ∅ 2,5 x 360mm, Peanut head



D 2030 ∅ 2 x 44mm
D 2031 ∅ 2,5 x 43mm
D 2032 ∅ 3 x 42mm
D 2033 ∅ 3,5 x 41mm



D 2017 Tracheal dilating forceps

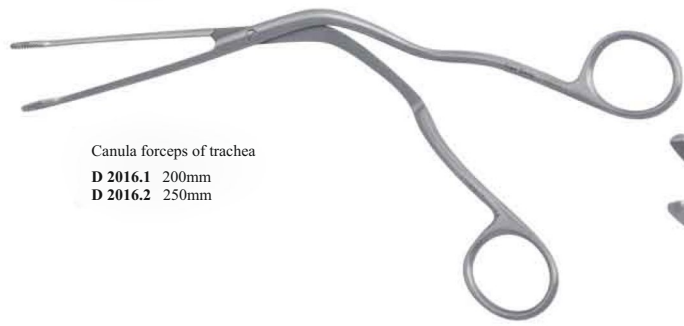

Canula forceps of trachea
D 2016.1 200mm
D 2016.2 250mm



D 2017.1 Tracheal dilating forceps



Tracheal tube
D 1001.1 (4mm)
D 1001.2 (5mm)
D 1001.3 (6mm)
D 1001.4 (7mm)
D 1001.5 (8mm)
D 1001.6 (9mm)
D 1001.7 (10mm)
D 1001.8 (11mm)
D 1001.9 (12mm)
D 1001.10 (13mm)



Trigeminal tracheal tube
D 1002.1 (4mm)
D 1002.2 (5mm)
D 1002.3 (6mm)
D 1002.4 (7mm)
D 1002.5 (8mm)
D 1002.6 (9mm)
D 1002.7 (10mm)
D 1002.8 (11mm)
D 1002.9 (12mm)



Single tube of total thread
D 1003.1 (9mm)
D 1003.2 (10mm)
D 1003.3 (11mm)
D 1003.4 (12mm)
D 1003.5 (13mm)
D 1003.6 (14mm)



Double tube of total thread
D 1004.1 (9mm)
D 1004.2 (10mm)
D 1004.3 (11mm)
D 1004.4 (12mm)
D 1004.5 (13mm)
D 1004.6 (14mm)





Laryngologia



Bronchoscopy instruments



Guthrie retractor



J 2019 Two claws



J 2019.1 Four claws



Three claws
J 2019.3 Sharp head
J 2019.6 Blunt head



Demarres retractor

- J 2019.10 8mm
- J 2019.11 10mm
- J 2019.12 12mm
- J 2019.13 14mm
- J 2019.14 16mm
- J 2019.15 18mm



Suction tube

- J 2020.1 (∅ 2,5 x 350mm)
- J 2020.2 (∅ 3 x 350mm)
- J 2020.3 (∅ 4 x 350mm)

Esophagoscopy instruments



Esophagoscope tube

- K 1001 8x10x200mm
- K 1001.1 7,5x10x200mm
- K 1001.2 8x11x180mm
- K 1002.1 10x12x250mm
- K 1002.2 10x12x300mm
- K 1003.1 12x14x300mm
- K 1003.2 12x14x350mm
- K 1004 14x16x400mm



Esophagoscope tube, with fiber inside

- K 1005 9x13x250mm
- K 1005-D 7,5x10x250mm
- K 1006 11x15x300mm
- K 1007.1 10x16x360mm
- K 1007.2 10x16x400mm
- K 1008 13x17x380mm
- K 1009.1 12x18x250mm
- K 1009.2 12x18x400mm
- K 1009.3 12x18x450mm



- K 2014 Spatula, straight
- K 2014.1 180mm, Spatula, straight



K 1000 Handle



K 2014.2 180mm, Spatula, straight



K 2015 Spatula, curved

Optec s.c.

ul. Alberta 6E, 16-001 Księżyno k. Białegostoku
tel. 85 743 74 17, 85 878 16 10 wew. 102
e-mail: medycyna@optec.pl



Esophagoscopy instruments

Esophageal foreign body forceps

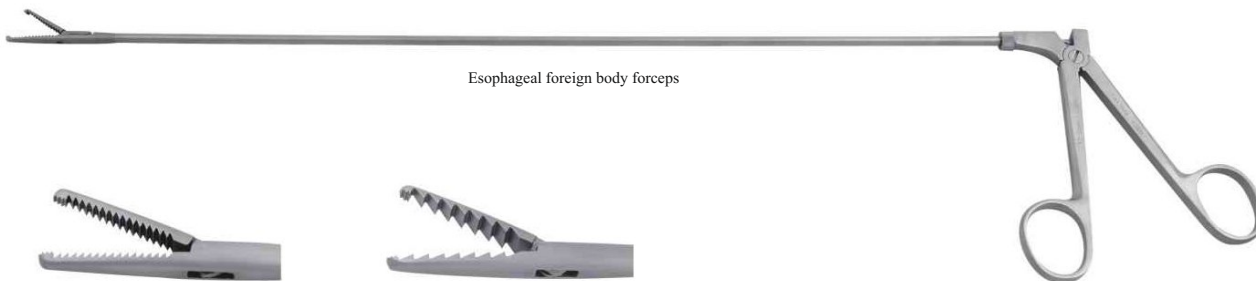

K 2002.1 ∅ 4 x 350mm
K 2002.2 ∅ 4 x 450mm
K 2003.1 ∅ 4 x 380mm
K 2003.2 ∅ 4 x 450mm
K 2003.3 ∅ 4 x 500mm



K 2001.1 ∅ 4 x 350mm
K 2001.2 ∅ 4 x 450mm
K 2004.1 ∅ 4 x 380mm
K 2004.2 ∅ 4 x 450mm
K 2004.3 ∅ 4 x 500mm



K 2005.1 ∅ 4 x 380mm
K 2005.2 ∅ 4 x 450mm
K 2005.3 ∅ 4 x 500mm



K 2006.1 ∅ 4 x 380mm
K 2006.2 ∅ 4 x 450mm
K 2006.3 ∅ 4 x 500mm

Esophageal foreign body forceps



K 2007 ∅ 3,4 x 450mm
 Left curved



K 2008 ∅ 3,4 x 450mm
 Right curved



K 2009 ∅ 3,4 x 450mm
 Rotatable



K 2012.2 ∅ 4 x 450mm
 Right curved



K 2012.1 45° ∅ 4 x 380mm
 Cup head



K 2010 ∅ 3,4 x 450mm
 Straight

Esophageal foreign body forceps



K 2011 ∅ 3,4 x 450mm
 Esophageal scissors, straight



K 2013 ∅ 4 x 380mm
 Esophageal foreign body forceps, cutting

Suction tube

K 2016.1 ∅ 4 x 450mm
K 2016.2 ∅ 3 x 450mm
K 2016.3 ∅ 2,5 x 450mm



Laryngologia



Ventriculoscopy instruments

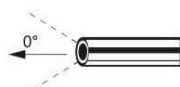

1. Connecting to TIANSONG light guide cable
Connecting to OLYMPUS light guide cable
Connecting to STORZ light guide cable
2. Connecting to WOLF light guide cable
3. Connecting to ACMI, STRYKER light guide cable



Endoscope \varnothing 2,7 x 205mm
 N 0010 0°
 N 0011 30°

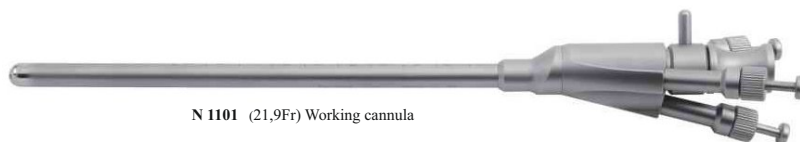

N 1101 (21,9Fr) Working cannula



Electrode 305mm
 N 3101 Hook
 N 3102 Blunt
 N 3103 Needle
 N 3104 Bipolar electric coagulator



Suction tube 170mm
 N 2105.1 \varnothing 2,5mm
 N 2105.2 \varnothing 3,0mm
 N 2105.3 \varnothing 3,5mm
 N 2105.4 \varnothing 4,0mm
 N 2105.5 \varnothing 5,0mm



N 1003 Endoscope holder



Endoscopy flexible forceps \varnothing 2 x 350mm



K 2101 Micro scissors, sharp



K 2102 Micro scissors, blunt



K 2103 Micro biopsy forceps



K 2104 Micro grasping forceps

Optec s.c.

ul. Alberta 6E, 16-001 Księżyno k. Białegostoku
 tel. 85 743 74 17, 85 878 16 10 wew. 102
 e-mail: medycyna@optec.pl





Laryngologia

Endoscopy camera system

NT-501

Endoscope Camera Documentation System

01. F-168D CCD camera, 480 lines
02. Coupler, F23, Water Proof
03. Pushcard, with multifunctional shelf
04. Computer Intel/2G/500G/DVD Recorder
05. Monitor, 19" LCD
06. Printer, HP4800DPI high resolution print
07. Foot pedal
08. Video capture card, PHILIPS chip highest quality of image, HD digital DVD level, dynamic magnification, dynamic filter processing
09. Software, can make DVD replay/ record, print, many template/ word / stock/ photo stock, powerful function of case management
10. Video teaching of the system, comprehensive teaching of the whole system
11. Automatic system recovery, fast recovery to factory setting in 20 mins



NT-618

Endoscopy Camera System (Water Proof, LCD Panel)

01. 618 Single chip medical camera (LCD Panel), 480 lines, immersible camera lens from Japan
02. Couper, Water Prof.
03. 15" SONY or 17" SAMSUNG Monitor
04. Pushcard, with multifunctional shelf



NT-638

Endoscope Camera System (Water Proof, LCD Panel)

01. 638 Three chip medical camera 800 lines, immersible camera lens from Japan
02. Coupler, Water Proof
03. 21" SONY or 15" JVC Monitor
04. Pushcard, with multifunctional shelf



NT-668

Endoscope Camera System (Water Proof, HD)

01. 668 HD medical camera, 1080P, immersible camera lens from Japan
02. Coupler, Water Proof
03. 26" PANASONIC medical HD monitor
04. Pushcard, with multifunctional shelf



Optec s.c.

ul. Alberta 6E, 16-001 Księżyno k. Białogostoku
tel. 85 743 74 17, 85 878 16 10 wew. 102

e-mail: medycyna@optec.pl





Laryngologia



Endoscopy camera system

NT-668A

Endoscopy Camera System

- 01. Full - HD camera, LCD screen, 1080P, immersible camera head for disinfection
- 02. Water prof coupler (Zoom coupler is opcional)
- 03. 24 inch medical monitor, (27 inch medical monitor optional)
- 04. LED cold light source
- 05. Trolley with drawer and patch board



NT-268A

Endoscopy Camera System

- 01. HD camera, 1080P, immersible camera head for disinfection
- 02. F 14 Water prof. coupler
- 03. 24 inch medical monitor
- 04. LED cold light source
- 05. Trolley with drawer and patch board



Surveillance Monitor



A 2502.16 SONY, 15 inch
A 2502.10 SONY, 21 inch
A 2502.22 SONY, 24 inch, High definition



A 2502.18 PANASONIC, 26 inch High definition



A 2502.23 BARCO, 26 inch High definition



A 2502.25 24 inch, made in China



A 2502.24 Caring 24 inch, High definition, made in China
A 2502.26 Caring 15 inch, made in China

Optec s.c.

ul. Alberta 6E, 16-001 Księżyno k. Białegostoku
tel. 85 743 74 17, 85 878 16 10 wew. 102
e-mail: medycyna@optec.pl





Laryngologia

Light sources



M-OSW-LED-120-HCM-9698
Light source HCM 9698 LED 120W



M-OSW-LED-50-HCM-9671
Light source HCM 9671 LED 50W



M-OSW-HAL-150-1-XD 301-S
Light source XD 301, 150W, jednocanalowe



M-OSW-HAL-150-2-XD 301-S
Light source XD 301, 2 x 150W, STORZ



M-OSW-HAL-250-2-XD 301-S
Light source XD 301, 2 x 250W, STORZ



M-OSW-R-LED-3W-1
Portable LED light 3W

Medical optica fiber

Universal adapter.



Stryker



Wolf



Storz/Olympus

Universal adapter.



Storz



Wolf



Olympus



M-SM-1800-35 -U-U
M-SM-2300-35 -U-U
M-SM-3000-35 -U-U
M-SM-3500-35 -U-U
M-SM-1800-48 -U-U
M-SM-2300-48 -U-U
M-SM-2500-48 -U-U
M-SM-3000-48 -U-U
M-SM-3500-48 -U-U

Medical opticalfiber Optec 1,8m \varnothing 3,5Universal/Universal
Medical opticalfiber Optec 2,3m \varnothing 3,5Universal/Universal
Medical opticalfiber Optec 3,0m \varnothing 3,5Universal/Universal
Medical opticalfiber Optec 3,5m \varnothing 3,5Universal/Universal
Medical opticalfiber Optec 1,8m \varnothing 4,8Universal/Universal
Medical opticalfiber Optec 2,3m \varnothing 4,8Universal/Universal
Medical opticalfiber Optec 2,5m \varnothing 4,8Universal/Universal
Medical opticalfiber Optec 3,0m \varnothing 4,8Universal/Universal
Medical opticalfiber Optec 3,5m \varnothing 4,8Universal/Universal

\varnothing 5.0< kabel nietypowy; wycena indywidualna





Laryngologia



Endoscopic cameras



M-KAM-HD-UC-100
Endoscope camera UC-100 Full HD USB 3.0



M-KAM-CYMO-HD 1156
Endoscope camera CYMO HD 1156



M-KAM-CYMO-HD 6180
Endoscope camera CYMO HD 6180

Medical containers for sterilization



M-END-STO-2
Endoscope sterilization set



M-AKC-WIESZAK
Optics hanger for sterilization



Medical instruments sterilizing boxes



B 000.3A
For Sinuscopy instruments 380x210x70mm



B 0000.6
Sterilizing box for Sinuscope 300x80x52mm nets



190001000
Endoscope instruments in common use 500x245x70mm



B 0000.2
For Sinuscopy set 360x255x90mm



Sterilizing boxing for Otoscopy instruments
C 0000.1 230x165x110mm, 3 tiers
C 0000.2 230x165x70mm, 2 tiers



B 0000.4
For Endoscope set 255x71x36mm



B 0000.5
For Endoscope, autoclavable 255x71x36mm

Optec s.c.

ul. Alberta 6E, 16-001 Ksiezyno k. Bialogostoku
tel. 85 743 74 17, 85 878 16 10 wew. 102
e-mail: medycyna@optec.pl



Laryngological unit

NET-1100 Laryngological unit

Specifications:

- Spray
- Suction
- Medical bottles
- Equipment anti-fog
- Heating system
- Telescopic handle



NET-1100
Laryngological unit

KAU-3000 BASIC Laryngological unit

Specifications:

- Compressor pump
- Vacuum pump (main)
- Main suction bottle
- Sub suction bottle
- Clean system
- Power consumption
- Voltage
- Frequency
- Dimension
- Weight
- Anti-fog device



KAU-3000 BASIC
Laryngological unit

Endoscopic diagnostic set

M-EZD-4

Endoscopic diagnostic set:

- sinuscope
- otoscope
- laryngoscope
- camera FULL HD USB 3.0



M-EZD-4
Diagnostic endoscopic unit

Laryngological magnifying glass



Diagnostic loupes
Enlarge the picture: 2,5x- 3,5x
Working distance: 340mm-550mm



Surgical loupes
Enlarge the picture: 4x- 6x
Working distance: 340mm-550mm



Laryngologia



Usługi serwisowe

Usługi serwisowe:

- naprawa endoskopów
- naprawa światłowodów

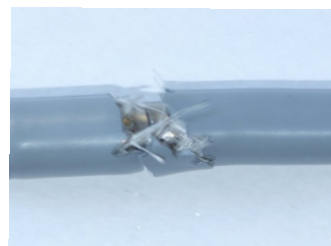
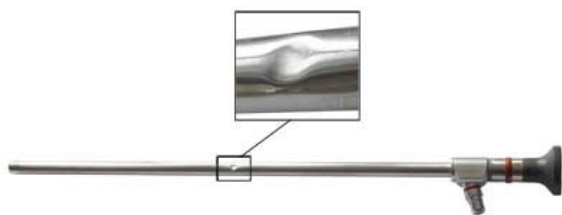

Usługi serwisowe

WYSOKA JAKOŚĆ USŁUG - GWARANCJA - ATRAKCYJNE CENY - SZYBKI SERWIS

Firma **OPTEC** od wielu lat prowadzi serwis gwarancyjny i pogwarancyjny sprzętu medycznego wykorzystującego włókna światłowodowe. Nasze naprawy przeprowadzane są przez wykwalifikowanych pracowników przy użyciu specjalistycznego sprzętu i urządzeń. Dysponujemy ogromnym doświadczeniem, wiedzą oraz zapleczem technicznym, które pozwala na dokonanie profesjonalnych napraw.

Prowadzimy serwis i przeglądy techniczne następujących sprzętów:

- optyk endoskopowych sztywnych (artroskopy, laryngoskopy, otoskopy, sinuszkopy, etc.),
- endoskopów giętkich (fiberoskopy, gastroskopy, kolonoskopy, nasofaryngoskopy, etc.),
- światłowodów medycznych oświetleniowych,
- światłowodów do laserów,
- elementów światłowodowych haków chirurgicznych, rektoskopów, amnioskopów, anoskopów, waginoskopów.

Dzięki naszemu zaangażowaniu możemy pochwalić się szeroką rzeszą stałych klientów.

To co nas wyróżnia na tle podobnych firm, to:

- bezpłatna wycena kosztów naprawy,
- stosowanie materiałów najwyższej jakości,
- krótkie terminy realizacji,
- gwarancja na wykonane czynności i zastosowane elementy.

**Jeżeli macie państwo jakieś pytania, chcecie się dowiedzieć czy możemy naprawić państwa sprzęt ?
Zapraszamy serdecznie do kontaktu telefonicznego lub mailowego z naszą firmą.**





Laryngologia

Usługi serwisowe

Naprawa światłowodów

Specjalizujemy się w naprawach wszystkich typów światłowodów, w tym kabli do laserów i aparatury optoelektronicznej.

Włókna światłowodowe są najbardziej narażonym na uszkodzenia elementem aparatury, a ich zniszczenie uniemożliwia pracę całego systemu. Dlatego właśnie dbamy aby naprawy wykonywane były możliwie najszybciej.

Na przykład bardzo częsta usterka jaką jest uszkodzenie włókna przy konektorze naprawiana jest nie dłużej niż w dwa dni od dostarczenia.

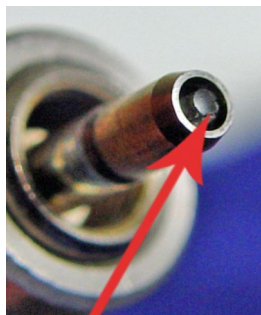

Czolo światłowodu przed naprawą

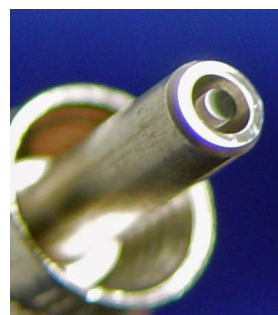

Czolo światłowodu po naprawie



Wykonujemy regenerację osłony ochronnej lub jej wymianę na nową.

Istnieje możliwość instalacji nowego włókna światłowodowego.

Naprawiamy zniszczone końcówki bądź zmieniamy na inne.

Bezpłatnie określamy koszty naprawy

Stosujemy materiały i kleje najwyższej jakości

Na naprawiony sprzęt udzielamy 6 miesięcy gwarancji



OPTEC s.c. jest firmą z 30-letnim doświadczeniem działającą w branży medycznej.

Specjalizujemy się we wszelkiego rodzaju kablach światłowodowych do medycyny oraz optykach endoskopowych.

Oferujemy sprzęt medyczny do artroskopii, ginekologii, laryngologii, laparoskopii, proktologii, urologii w bardzo konkurencyjnych cenach.



W naszej ofercie znajdują się: wszelkiego rodzaju światłowody do medycyny, źródła światła, oświetlacze czołowe, optyki endoskopowe sztywne i giętkie, wzierniki, tory wizyjne, kamery, unity, narzędzia chirurgiczne, haki operacyjne, lupy zabiegowe, wózki endoskopowe, pojemniki sterylizacyjne oraz wiele innych produktów. posiadamy prawie wszystkie rodzaje optyk sztywnych.

Dużym atutem naszej firmy jest szybki i atrakcyjny cenowo serwis wszystkich typów światłowodów, endoskopów sztywnych i giętkich (Storz, Wolf, Olympus, Stryker, Fujinon, Pentax, ACMI i inne), a także światłowodów specjalnych np. do lasera(lipoliza, metoda EVLT, urologia).

Optec s.c.

ul. Alberta 6E, 16-001 Księżyno k. Białegostoku

tel. 85 743 74 17, 85 878 16 10

Fax 85 734 18 15

e-mail: [marcin @optec.pl](mailto:marcin@optec.pl)

